

Rohtas

ENTERPRISE

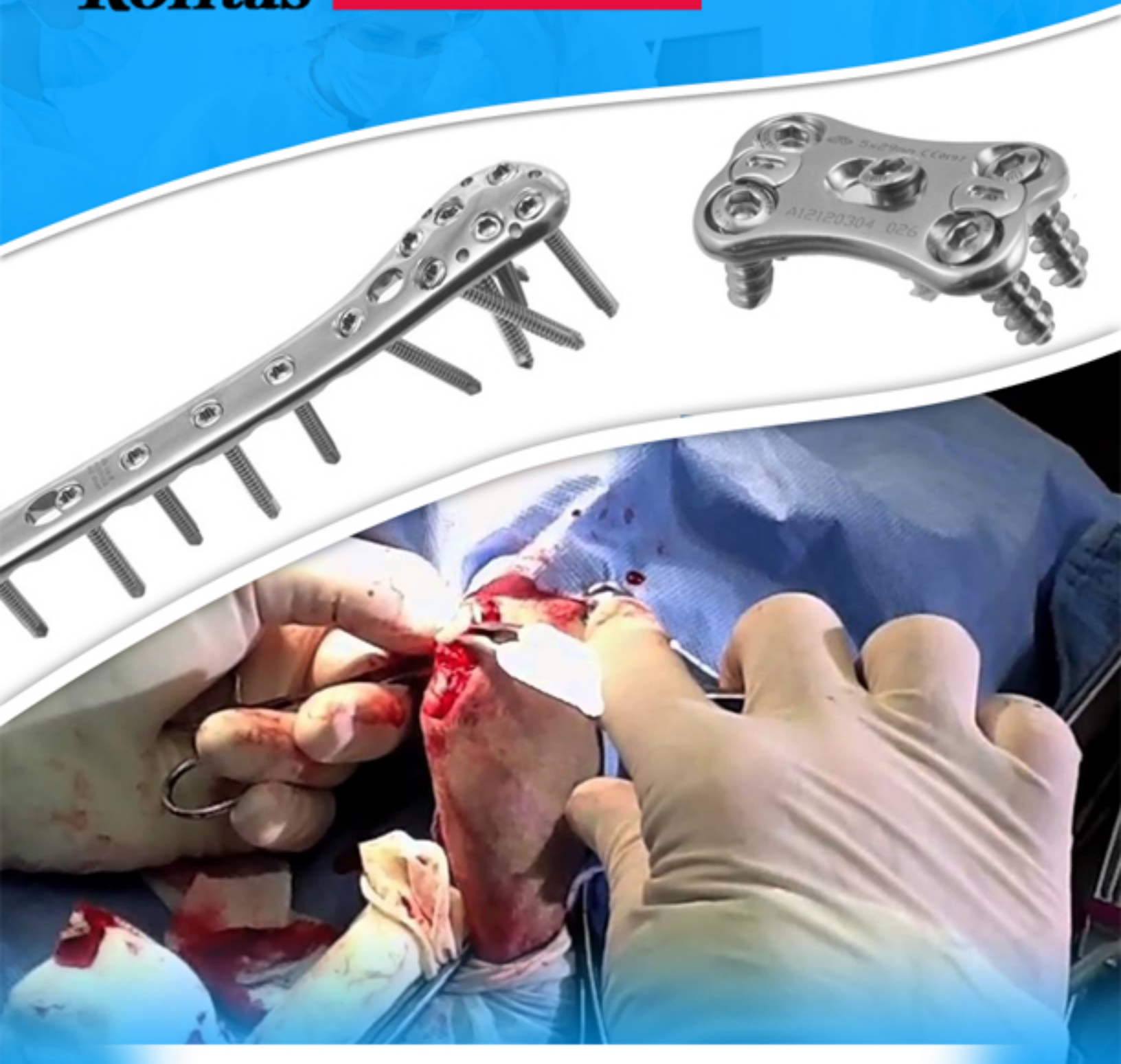

ORTHOPEDIC IMPLANTS

PRODUCTS CATALOGUE

www.rohtasentp.com

Bone Plates

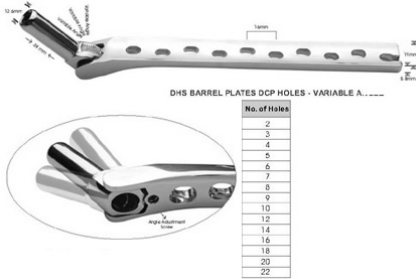

**Angled Blade Plates
RI-93-1001**

DHS - DCS - Angled Blade Plates

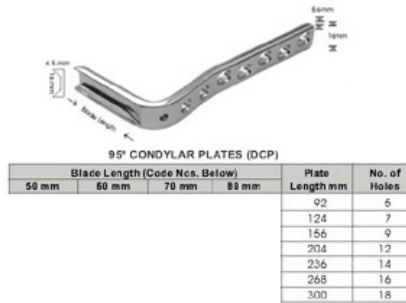

**Angled Blade Plates
RI-93-1002**

DHS - DCS - Angled Blade Plates
92mm, 124mm, 156 mm, 204 mm, 236 mm, 268 mm, 300 mm,

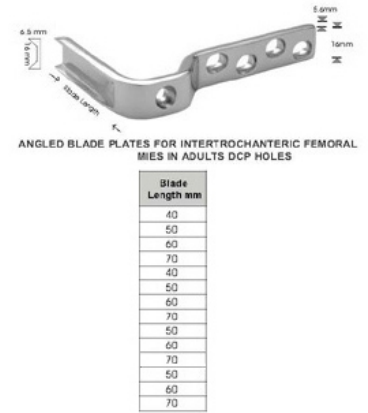

**Angled Blade Plates
RI-93-1004**

DHS - DCS - Angled Blade Plates
40 mm, 50 mm, 60 mm, 70 mm, 40 mm, 50 mm, 60 mm, 70 mm, 40 mm, 50 mm,



**Angled Blade Plates
RI-93-1006**

DHS - DCS - Angled Blade Plates



**Angled Blade Plates
RI-93-1007**

DHS - DCS - Angled Blade Plates

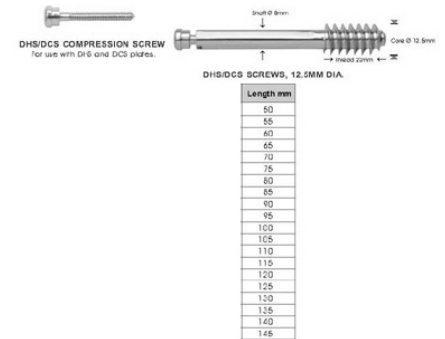

**Angled Blade Plates
RI-93-1009**

DHS - DCS - Angled Blade Plates
50 mm, 55 mm, 60 mm, 65 mm, 70 mm, 75 mm, 80 mm, 85 mm, 90 mm, 95 mm,

Bone Plates



95° DCS PLATES DCP HOLES

No. of Holes	Length in mm
6	100
7	115
8	130
9	146
10	163
12	198
14	225
16	260
18	306
20	338
22	370

Angled Blade Plates

RI-93-1010

 DHS - DCS - Angled Blade Plates
100 mm, 115 mm, 130 mm, 146 mm, 163 mm, 198 mm, 225 mm, 260 mm, 306 mm, 338 mm,

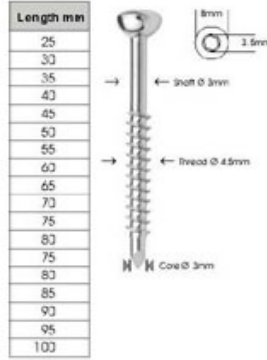

Angled Blade Plates

RI-93-1012

Large Fragment Plates
25 mm, 33 mm, 35 mm, 43 mm, 45 mm, 53 mm, 55 mm, 63 mm, 65 mm, 73 mm,



Lengthening in mm	Length in mm
30	135
40	145
50	155
60	165

Large Fragment Plates

RI-93-1014

 Large Fragment Plates



CONDYLAR BUTTRESS PLATES 4.5mm FOR LEFT & RIGHT LEG

No. of Holes	No. of Holes
7	7
9	9
11	11
12	12
13	13
15	15

Large Fragment Plates

RI-93-1017

Large Fragment Plates



T-BUTTRESS PLATE FOR 4.5MM SCREWS

No. of Holes	Length mm
4	81
5	96
6	112
7	128
8	144
9	160
10	176
11	192
12	208
13	224
14	240

Large Fragment Plates

RI-93-1022

 Large Fragment Plates
81 mm, 96 mm, 112 mm, 128 mm, 144 mm, 160 mm, 176 mm, 192 mm, 208 mm, 224 mm,



L-BUTTRESS PLATE 4.5mm FOR LEFT & RIGHT LEG

No. of Holes	Length in mm	No. of Holes	Length in mm
2	69	3	67
4	85	4	85
5	101	5	101
6	117	6	117
7	133	7	133
8	149	8	149
9	165	9	165
10	181	10	181
11	197	11	197
12	213	12	213
13	229	13	229
14	245	14	245

Large Fragment Plates

RI-93-1023

 Large Fragment Plates
69 mm, 85 mm, 101 mm, 117 mm, 133 mm, 149 mm, 165 mm, 181 mm, 197 mm, 213 mm,

Bone Plates



HOOK PLATE 4.5MM WITH DCP 6 HOLES

No. of Holes	Height mm
6	128

**Large Fragment Plates
RI-93-1024**

 Large Fragment Plates
128 mm,



LIMITED CONTACT DYNAMIC COMPRESSION PLATE (L-DCP) FOR 4.5MM SCREWS (NARROW)

No. of Holes	Length mm
4	70
5	88
6	106
7	124
8	142
9	160
10	178
11	196
12	214
13	232
14	250
15	268
16	286

**Large Fragment Plates
RI-93-1025**

 Large Fragment Plates
70 mm,88 mm,106 mm,124 mm,142 mm,160 mm,178 mm,196 mm,214 mm,232 mm,



4.5MM SEMI-TUBULAR PLATES HEAVY DUTY

No. of Holes	Length mm
4	71
5	87
6	103
7	119
8	135
9	151
10	167
11	183
12	199

**Large Fragment Plates
RI-93-1027**

 Large Fragment Plates
71 mm,87 mm,103 mm,119 mm,135 mm,151 mm,167 mm,183 mm,199 mm,



SPOON PLATE

No. of Holes	Length mm
5	100
6	120

**Large Fragment Plates
RI-93-1028**

 Large Fragment Plates
100 mm,120 mm,



T-PLATE FOR 4.5MM SCREWS

No. of Holes	Length mm
3	68
4	84
5	100
6	116
7	132
8	148
9	164
10	180
11	196
12	212
13	228
14	244

**Large Fragment Plates
RI-93-1029**

 Large Fragment Plates
68 mm,84 mm,100 mm,116 mm,132 mm,148 mm,164 mm,180 mm,196 mm,212 mm,



L-BUTTRESS PLATE 4.5mm FOR LEFT & RIGHT LEG

No. of Holes	Length in mm	No. of Holes	Length in mm
3	69	3	69
4	85	4	85
5	101	5	101
6	117	6	117
7	133	7	133
8	149	8	149
9	165	9	165
10	181	10	181
11	197	11	197
12	213	12	213
13	229	13	229
14	245	14	245

**Large Fragment Plates
RI-93-1031**

 Large Fragment Plates
69 mm,85 mm,101 mm,117 mm,133 mm,149 mm,165 mm,181 mm,197 mm,213 mm,

Bone Plates



No. of Holes	Height mm
6	128

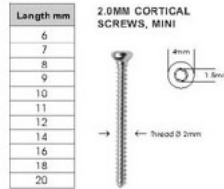

Length mm
6
7
8
9
10
11
12
14
16
18
20



DCP PLATES - 2.0MM

No. of Holes
4
5
6
7
8

Large Fragment Plates

RI-93-1032

Large Fragment Plates
128 mm,

Mini Fragments Implants & Instruments

RI-93-1034

Plates For 2.0mm-1.5mm screws
6 mm,7 mm,8 mm,9 mm,10 mm,11 mm,12 mm,14 mm,16 mm,18 mm,

Mini Fragments Implants & Instruments

RI-93-1036

Plates For 2.0mm-1.5mm screws



MINI T PLATE FOR 2MM SCREWS



MINI L PLATE FOR 2MM SCREWS

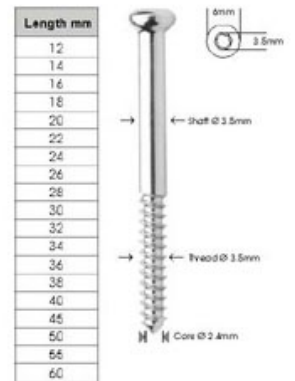

Length mm
12
14
16
18
20
22
24
26
28
30
32
34
36
38
40
45
50
55
60

Mini Fragments Implants & Instruments

RI-93-1037

Plates For 2.0mm-1.5mm screws

Mini Fragments Implants & Instruments

RI-93-1038

Plates For 2.0mm-1.5mm screws

Mini Fragments Implants & Instruments

RI-93-1039

Plates For 2.0mm-1.5mm screws
12 mm,14 mm,16 mm,18 mm,20mm,22 mm,24 mm,26 mm,28 mm,30 mm,

Bone Plates

3.5MM MALLEOLAR SCREW

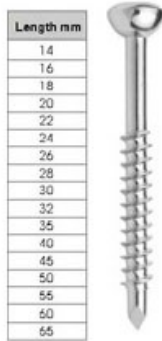

Mini Fragments Implants & Instruments
RI-93-1040

 Plates For 2.0mm-1.5mm screws
14 mm, 16 mm, 18 mm, 20 mm, 22 mm, 24 mm, 26 mm, 28 mm, 30 mm, 32 mm,

3.5MM SHAFT SCREW FOR LC-DCP

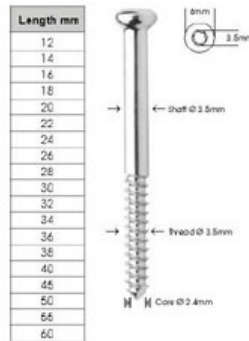

Small Fragments Implants & Instruments
RI-93-1041

DCP Plate for 2.7mm Screws
12 mm, 14 mm, 16 mm, 18 mm, 20 mm, 22 mm, 24 mm, 26 mm, 28 mm, 30 mm,

3.5MM MALLEOLAR SCREW



Small Fragments Implants & Instruments
RI-93-1042

 DCP Plate for 2.7mm Screws



QUARTER TUBULAR PLATE FOR 2.7MM SCREWS

No. of Holes	Length mm
2	18
3	26
4	34
5	42
6	50
7	58
8	66
9	74
10	82



Small Fragments Implants & Instruments
RI-93-1044

 DCP Plate for 2.7mm Screws
20 mm, 28 mm, 36 mm, 44 mm, 52 mm, 60 mm, 68 mm, 76 mm, 84 mm, 100 mm,



L PLATE FOR 2.7MM SCREWS

Small Fragments Implants & Instruments
RI-93-1043

 DCP Plate for 2.7mm Screws
18 mm, 26 mm, 34 mm, 42 mm, 50 mm, 58 mm, 66 mm, 74 mm, 82 mm,

Small Fragments Implants & Instruments
RI-93-1045

 DCP Plate for 2.7mm Screws

Bone Plates



RECONSTRUCTION PLATE FOR 2.7MM SCREWS
STRAIGHT / CURVED

No. of Holes	No. of Holes
2	2
3	3
4	4
5	5
6	6
7	7
8	8
9	9
10	10
11	11
12	12
14	14
16	16
18	18
20	20
22	22
24	24



ONE THIRD TUBULAR PLATES

No. of Holes	Length mm
2	28
3	40
4	52
5	64
6	76
7	88
8	100
9	112
10	124
11	136
12	148



ONE-THIRD TUBULAR PLATE WITH COLLAR

No. of Holes	Length mm
2	28
3	40
4	52
5	64
6	76
7	88
8	100
9	112
10	124
11	136
12	148

Small Fragments Implants & Instruments

RI-93-1047

 DCP Plate for 2.7mm Screws

Small Fragments Implants & Instruments

RI-93-1048

 DCP Plate for 2.7mm Screws
28 mm,40 mm,52 mm,64 mm,76 mm,88
mm,100 mm,112 mm,124 mm,136 mm,

Small Fragments Implants & Instruments

RI-93-1049

DCP Plate for 2.7mm Screws
28 mm,40 mm,52 mm,64 mm,76 mm,88
mm,100 mm,112 mm,124 mm,136 mm,



3.5MM STRAIGHT PELVIC RECONSTRUCTION PLATES
STRAIGHT / CURVED

No. of Holes	Length in mm	No. of Holes
5	58	5
6	70	6
7	82	7
8	94	8
9	106	9
10	118	10
11	130	11
12	142	12
13	154	13
14	166	14
15	178	15
16	190	16
17	202	17
18	214	18
19	226	19
20	238	20
21	250	21
22	262	22

Small Fragment Plates

RI-93-1050

Small Fragments Implants &
Instruments
58 mm,70 mm,82 mm,94 mm,106 mm,118
mm,130 mm,142 mm,154 mm,166 mm,



No. of Holes	Length mm
3	88
4	104
5	120
6	136
7	152
8	168
9	184
10	200
11	216
12	232

Small Fragment Plates

RI-93-1051

Small Fragments Implants &
Instruments
88 mm,104 mm,120 mm,136 mm,152
mm,168 mm,184 mm,200 mm,216 mm,232
mm,



HOOK PLATE FOR 3.5MM SCREWS

Small Fragment Plates

RI-93-1052

 Small Fragments Implants &
Instruments

Bone Plates



Y-RECONSTRUCTION PLATES

Size	No. of Holes
Small	6
Medium	9
Large	12

Small Fragment Plates

RI-93-1054

 Small Fragments Implants & Instruments



CALCANEAL PLATE FOR 3.5MM SCREWS
For Calcaneus Fractures. Fixation with 3.5mm and 4mm screw

Length mm
60
70

Small Fragment Plates

RI-93-1055

 Small Fragments Implants & Instruments
60 mm, 70 mm,

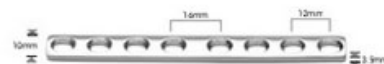

DCP PLATES - 3.5MM

No. of Holes	Length mm
2	25
3	37
4	49
5	61
6	73
7	85
8	97
9	109
10	121
11	133
12	145
13	157
14	169

Small Fragment Plates

RI-93-1056

 Small Fragments Implants & Instruments
25 mm, 37 mm, 49 mm, 61 mm, 73 mm, 86 mm, 97 mm, 109 mm, 121 mm, 133 mm,



SMALL T-PLATES, RIGHT ANGLED, 3 HEAD

No. of Holes	Length mm
3	39
4	56
5	67
6	78

Small Fragment Plates

RI-93-1057

 Small Fragments Implants & Instruments
39 mm, 56 mm, 67 mm, 78 mm,



SMALL T-PLATES, OBLIQUE ANGLED

No. of Holes	Length mm
3	39
4	63
5	67
6	78
3	39
4	63
5	67
6	78

Small Fragment Plates

RI-93-1058

 Small Fragments Implants & Instruments
39 mm, 63 mm, 67 mm, 78 mm, 39 mm, 63 mm, 67 mm, 78 mm,



L PLATE FOR 2.7MM SCREWS

Small Fragment Plates

RI-93-1060

 Small Fragments Implants & Instruments

Bone Plates



T-PLATE FOR 2.7MM SCREWS

Small Fragment Plates

RI-93-1061

 Small Fragments Implants & Instruments



RECONSTRUCTION PLATE FOR 2.7MM SCREWS

STRAIGHT / CURVED	
No. of Holes	No. of Holes
2	2
3	3
4	4
5	5
6	6
7	7
8	8
9	9
10	10
11	11
12	12
14	14
16	16
18	18
20	20
22	22
24	24

Small Fragment Plates

RI-93-1062

 Small Fragments Implants & Instruments



Small Fragment Plates

RI-93-1063

Small Fragments Implants & Instruments
28 mm,40 mm,52 mm,64 mm,76 mm,88 mm,100 mm,112 mm,124 mm,136 mm,



ONE-THIRD TUBULAR PLATE WITH COLLAR

No. of Holes	Length mm
2	28
3	40
4	52
5	64
6	76
7	88
8	100
9	112
10	124
11	136
12	148

Small Fragment Plates

RI-93-1064

 Small Fragments Implants & Instruments

28 mm,40 mm,52 mm,64 mm,76 mm,88 mm,100 mm,112 mm,124 mm,136 mm,

Bone Screws & Washers

MINI FRAGMENTS IMPLANTS & INSTRUMENTS

PLATES

DCP PLATES - 2.0MM

Code No.	No. of Holes
121.854	4
121.855	6
121.856	8
121.857	7
121.858	8

MINI STRAIGHT PLATES FOR 2MM SCREWS

Code No.	No. of Holes
121.100	2
121.101	3
121.102	4
121.103	5
121.104	6
121.105	7
121.106	8

BONE SCREWS

1.5MM CORTICAL SCREWS, MINI

2.0MM CORTICAL SCREWS, MINI

MINI L PLATE FOR 2MM SCREWS

Code No.	Length mm	Code No.	Length mm
118.036	6	118.106	6
118.037	7	118.107	7
118.038	8	118.108	8
118.039	9	118.109	9
118.040	10	118.110	10
118.041	11	118.111	11
118.042	12	118.112	12
118.043	14	118.114	14
118.044	16	118.116	16
118.045	18	118.118	18
118.046	20	118.120	20

MINI T PLATE FOR 2MM SCREWS

Code No.	Length mm	Code No.	Length mm
118.036	6	118.106	6
118.037	7	118.107	7
118.038	8	118.108	8
118.039	9	118.109	9
118.040	10	118.110	10
118.041	11	118.111	11
118.042	12	118.112	12
118.043	14	118.114	14
118.044	16	118.116	16
118.045	18	118.118	18
118.046	20	118.120	20

Cortical Screws

RI-93-1108

 1.5mm & 2mm Cortical Screws
1.5mm, 2mm,

SMALL FRAGMENTS IMPLANTS & INSTRUMENTS

4.0MM CANCELLOUS SCREWS, BONY THREAD

4.0MM CANCELLOUS SCREWS, FULL THREAD

3.5MM CANCELLOUS SCREWS

Code No.	Length mm	Code No.	Length mm	Code No.	Length mm
100.016	10	100.017	12	100.018	12
100.019	14	100.020	14	100.021	14
100.022	16	100.023	16	100.024	16
100.025	18	100.026	18	100.027	18
100.028	20	100.029	20	100.030	20
100.031	22	100.032	22	100.033	22
100.034	24	100.035	24	100.036	24
100.037	26	100.038	26	100.039	26
100.040	28	100.041	28	100.042	28
100.043	30	100.044	30	100.045	30
100.046	32	100.047	32	100.048	32
100.049	34	100.050	34	100.051	34
100.052	36	100.053	36	100.054	36
100.055	38	100.056	38	100.057	38
100.058	40	100.059	40	100.060	40
100.061	42	100.062	42	100.063	42
100.064	44	100.065	44	100.066	44
100.067	46	100.068	46	100.069	46
100.070	48	100.071	48	100.072	48
100.073	50	100.074	50	100.075	50
100.076	52	100.077	52	100.078	52
100.079	54	100.080	54	100.081	54
100.082	56	100.083	56	100.084	56
100.085	58	100.086	58	100.087	58
100.088	60	100.089	60	100.090	60

CANCELLOUS WASHER

Washer with 4.0mm Cancellous Screws
Code No. 110.010

Cancellous Screws

RI-93-1110

 3.5mm Cancellous Screws
3.5mm,



Shaft Screw for LC-DCP

RI-93-1111

 3.5mm Shaft Screw for LC-DCP
3.5mm,



Cancellous Screws

RI-93-1112

4.0mm Cancellous Screws
4.0mm,

External Fixators

EXTERNAL FIXATORS — SMALL EXTERNAL FIXATOR

□ EXTERNAL FIXATOR FOR FOREARM & METACARPALS



CODE NO.	DESCRIPTION
RI-93-1201	External Fixator for Forearm & Metacarpals

**External Fixator for Forearm & Metacarpals
RI-93-1201**

 External Fixator for Forearm & Metacarpals

EXTERNAL FIXATORS — ILLIZAROV EXTERNAL FIXATORS

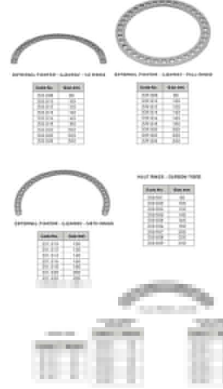

**Ilizarov External Fixators
RI-93-1202**

 Ilizarov External Fixators

EXTERNAL FIXATORS — MINI EXTERNAL FIXATORS

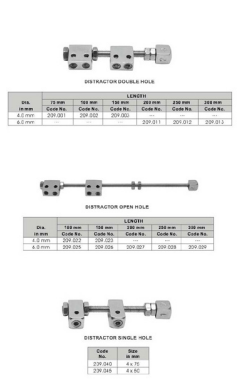

**Mini External Fixator
RI-93-1203**

 Mini External Fixator

— LARGE EXTERNAL FIXATOR
□ TUBULAR EXTERNAL FIXATOR



**Tubular External Fixator
RI-93-1204**

 Tubular External Fixator

Hip Replacements



**Austin Moore Extra Long Stem
RI-93-1301**

 Austin Moore Extra Long Stem

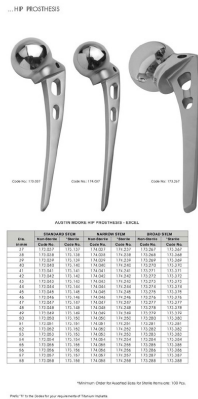

**Austin Moore Hip Prosthesis - Sterile - Non-Sterile
RI-93-1302**

 Austin Moore Hip Prosthesis - Sterile - Non-Sterile

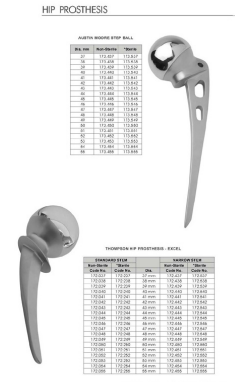

**Austin Moore Step Ball
RI-93-1303**

 Austin Moore Step Ball

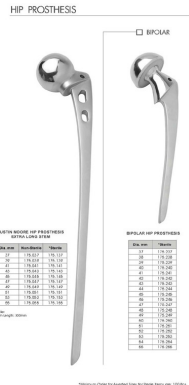

**Bipolar Hip Prosthesis - Sterile
RI-93-1304**

 Bipolar Hip Prosthesis - Sterile



**Modular Hip System -Sterile
RI-93-1305**

 Modular Hip System -Sterile

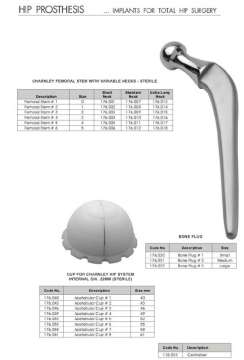

**Total Hip System - Sterile
RI-93-1306**

 Total Hip System - Sterile

Instruments

GENERAL INSTRUMENTS ... BONE DRILLS - MANUAL & ELECTRIC

Code No.	Description
100-110	Universal Bone Drill with S.S. Shank
100-111	Micro Bone Drill with S.S. Shank
100-112	Micro Bone Drill with S.S. Shank
100-113	Micro Bone Drill with S.S. Shank
100-114	Micro Bone Drill with S.S. Shank
100-115	Micro Bone Drill with S.S. Shank
100-116	Micro Bone Drill with S.S. Shank
100-117	Micro Bone Drill with S.S. Shank
100-118	Micro Bone Drill with S.S. Shank
100-119	Micro Bone Drill with S.S. Shank
100-120	Micro Bone Drill with S.S. Shank



Bone Drills - Manual & Electric RI-93-1402

 Bone Drills - Manual & Electric

... DRILL & SAW SYSTEM

Code No.	Description
DR-101	Hand Drill with 1/2" Shank, 1/2" Drill Bit, 1/2" Chuck, 1/2" Flange, 1/2" Gear, 1/2" Motor, 1/2" Switch, 1/2" Cord, 1/2" Case
DR-102	Hand Drill with 1/2" Shank, 1/2" Drill Bit, 1/2" Chuck, 1/2" Flange, 1/2" Gear, 1/2" Motor, 1/2" Switch, 1/2" Cord, 1/2" Case
DR-103	Hand Drill with 1/2" Shank, 1/2" Drill Bit, 1/2" Chuck, 1/2" Flange, 1/2" Gear, 1/2" Motor, 1/2" Switch, 1/2" Cord, 1/2" Case
DR-104	Hand Drill with 1/2" Shank, 1/2" Drill Bit, 1/2" Chuck, 1/2" Flange, 1/2" Gear, 1/2" Motor, 1/2" Switch, 1/2" Cord, 1/2" Case
DR-105	Hand Drill with 1/2" Shank, 1/2" Drill Bit, 1/2" Chuck, 1/2" Flange, 1/2" Gear, 1/2" Motor, 1/2" Switch, 1/2" Cord, 1/2" Case
DR-106	Hand Drill with 1/2" Shank, 1/2" Drill Bit, 1/2" Chuck, 1/2" Flange, 1/2" Gear, 1/2" Motor, 1/2" Switch, 1/2" Cord, 1/2" Case
DR-107	Hand Drill with 1/2" Shank, 1/2" Drill Bit, 1/2" Chuck, 1/2" Flange, 1/2" Gear, 1/2" Motor, 1/2" Switch, 1/2" Cord, 1/2" Case
DR-108	Hand Drill with 1/2" Shank, 1/2" Drill Bit, 1/2" Chuck, 1/2" Flange, 1/2" Gear, 1/2" Motor, 1/2" Switch, 1/2" Cord, 1/2" Case
DR-109	Hand Drill with 1/2" Shank, 1/2" Drill Bit, 1/2" Chuck, 1/2" Flange, 1/2" Gear, 1/2" Motor, 1/2" Switch, 1/2" Cord, 1/2" Case
DR-110	Hand Drill with 1/2" Shank, 1/2" Drill Bit, 1/2" Chuck, 1/2" Flange, 1/2" Gear, 1/2" Motor, 1/2" Switch, 1/2" Cord, 1/2" Case



Drill & Saw System - Complete RI-93-1407

 Drill & Saw System - Complete

SPINE SURGERY ... HARRINGTON IMPLANTS & INSTRUMENTS

HARRINGTON IMPLANTS

HARRINGTON ROD		HARRINGTON HOOKS	
Code No.	Size mm	Code No.	Description
197-216	25	197-210	Harrington Hook Upper - Sharp
197-217	31	197-211	Harrington Hook Upper - Blunt
197-218	38	197-212	Harrington Hook Lower - Sharp
197-219	45	197-213	Harrington Hook Lower - Blunt
197-220	52	197-214	Harrington Hook Lower - Sharp
197-221	60	197-215	Harrington Hook Lower - Blunt
197-222	68	197-216	Harrington Hook Lower - Sharp
197-223	76	197-217	Harrington Hook Lower - Blunt
197-224	84	197-218	Harrington Hook Lower - Sharp
197-225	92	197-219	Harrington Hook Lower - Blunt
197-226	100	197-220	Clip Washer

HARRINGTON INSTRUMENTS

Code No.	Description	GARNER/COBB SPINAL GUAGE
190-208	Harrington Punch	
190-210	Hook Holding Forceps - Left	
190-211	Hook Holding Forceps - Right	
190-212	Hook Spreader	
190-213	Threading Rod Clamp - Small	
190-214	Threading Rod Clamp - Large	
190-215	Hook Pusher - Straight	
190-216	Hook Pusher - Curved	
190-217	C Washer Holding Forceps	
190-218	Harrington Nail Bender	
190-219	Cut Taper	
190-220	Bender for Rod Shells (RHS)	

Harrington Instruments RI-93-1409

 Harrington Instruments

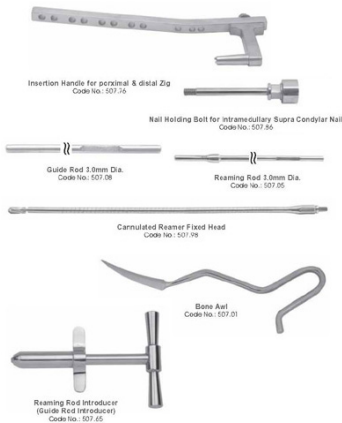

Instrument for Intramedullary Supra Condylar Nails RI-93-1410

 Instrument for Intramedullary Supra
Condylar Nails

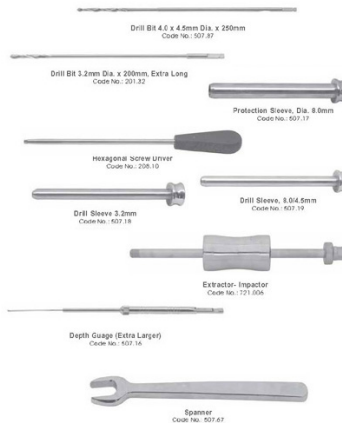

Instrument for Intramedullary Supra Condylar Nails RI-93-1412

 Instrument for Intramedullary Supra
Condylar Nails

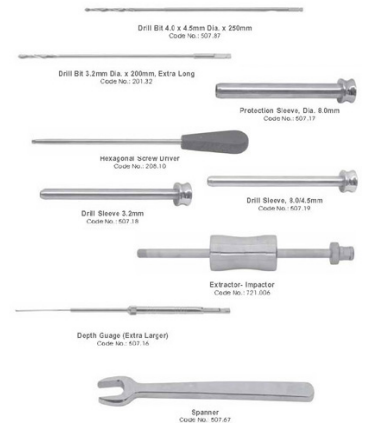

Instrument for Intramedullary Supra Condylar Nails RI-93-1413

 Instrument for Intramedullary Supra
Condylar Nails

Instruments

DHS / DCS & ANGLED BLADE PLATES

□ INSTRUMENTS FOR DHS / DCS & ANGLED BLADE PLATES



Instruments for DHS - DCS Plates
RI-93-1421

 Instruments for DHS - DCS Plates

DHS / DCS & ANGLED BLADE PLATES

□ INSTRUMENTS FOR DHS / DCS & ANGLED BLADE PLATES

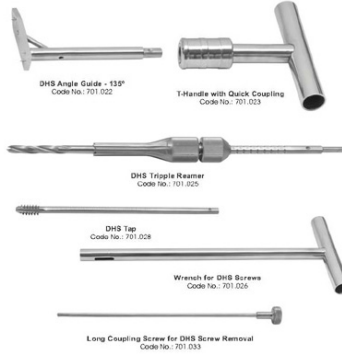

Instruments for DHS - DCS Plates
RI-93-1422

 Instruments for DHS - DCS Plates

DHS / DCS & ANGLED BLADE PLATES

□ INSTRUMENTS SETS FOR DCS PLATES

D.H.S. INSTRUMENTS SET

Code No.: 5516

Sr	Ordering of	Units
701.021	Quick Tap with Breakout Tip	1
701.022	DHS Angle Guide - 135°	1
701.023	T-Handle with Quick Coupling	1
701.024	Dist. Measuring Device	1
701.025	DHS Triplet Reamer	1
701.026	Wrench for DHS Screws	1
701.027	DHS Impactor	1
701.028	DHS Tap	1
701.029	Centering Sleeve for DHS Tap	1
701.029	Centering Sleeve for DHS Wrench	1
701.030	Centering Sleeve for DHS Reamer	1
701.031	Coupling Screw for Inserting DHS Screw	1
701.032	Guide Pin for Coupling Screw	1
701.033	Long Coupling Screw for DHS Screw Removal	1
701.034	Ball	1
400.005	S.S. Box with Two Rows	1 set

OPTIONAL INSTRUMENTS FOR DHS SET

701.040	DCS Right Reamer	1
701.041	DCS Angle Guide	1
701.042	DHS Right Reamer-Short Beam	1
701.043	DHS Angle Guide - 130°	1
701.044	DHS Angle Guide - 140°	1
701.045	DHS Angle Guide - 150°	1



D.H.S. IMPLANT SET

Code No.: 15517

Sr	Ordering of	Units
1	DHS/DCS Screw	18
1	each Length: 50, 70, 90, 100mm	
2	each Length: 50, 60, 65, 70, 75, 80, 85, 90mm	18
1	DHS/DCS Compression Screw	6
1	DHS Plate - 135°	6
2	each with 6, 8, 10 Holes	
1	each with 6 & 10 Holes	6
1	each with 6 and 12 Holes	6
2	each with 6 and 12 Holes	
1	S.S. Box with Two Rows	1 set

Instruments for DHS -DCS Plates
RI-93-1423

 Instruments for DHS -DCS Plates

...INSTRUMENTS FOR DHS / DCS & ANGLED BLADE PLATES

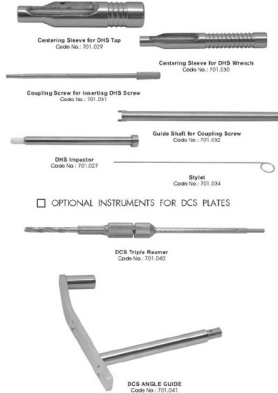

Instruments for DHS - DCS Plates
RI-93-1424

 Instruments for DHS - DCS Plates

NAILINGS ... INSTRUMENTS FOR HUMERUS NAILS

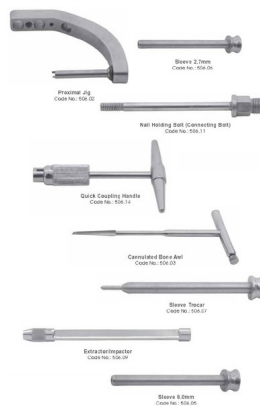

Instruments for Humerus Nails
RI-93-1425

 Instruments for Humerus Nails

... INSTRUMENTS FOR HUMERUS NAILS



Instruments for Humerus Nails
RI-93-1426

 Instruments for Humerus Nails

Instruments

MISCELLANEOUS IMPLANTS & INSTRUMENTS



JEWETT NAIL PLATES - 135"

Code No.	No. of Holes
1.76.104	4
1.76.106	6
1.76.106	6
1.76.107	7
1.76.108	8
1.76.109	9
1.76.110	10
1.76.112	12

INSTRUMENTS FOR JEWETT NAIL

Code No.	Description
387.010	Driver Handle
387.020	Starker for S.F. Nail
387.030	Impactor/Extractor for S.F. Nail
387.080	Jewett Nail Impactor - Extractor

Instruments for Jewett Nail Plate
RI-93-1427
 Instruments for Jewett Nail Plate

INSTRUMENTS FOR KNEE SURGERY & SKULL SURGERY

- INSTRUMENTS FOR KNEE SURGERY**
- 245.005 Bristle Knee Retractor
 - 245.010 Bristle Knee Retractor - Clasp
 - 245.015 Manual Compression Clamp
 - 245.020 Bristle Knee Joint Retractor (Set of 3)
 - 245.025 Bristle Manual Compression Clamp (Set of 3)
 - 245.030 Clasp Knee Compression Clamp
 - 245.035 Manual Compression Clamp

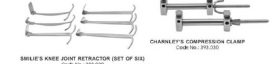

BRISTLE KNEE JOINT RETRACTOR (SET OF 3)
 Code No. 245.020

- INSTRUMENTS FOR SKULL SURGERY**
- 244.005 Gigli Saw wire - Standard
 - 244.010 Gigli Saw wire - Fine (D) product
 - 244.015 Gigli Saw handle - 18"
 - 244.020 Gigli Saw handle - 24"
 - 244.025 Gigli Saw handle - 30"
 - 244.030 Gigli Saw handle with 2.5mm hole
 - 244.035 Gigli Saw handle with 3mm hole
 - 244.040 Gigli Saw handle with 3.5mm hole
 - 244.045 Gigli Saw handle with 4mm hole
 - 244.050 Gigli Saw handle with 5mm hole



GIGLI SAW HANDLE - FINER
 Code No. 244.010

Instruments for Knee Surgery & Skull Surgery
RI-93-1428
 Instruments for Knee Surgery & Skull Surgery

INSTRUMENTS FOR KNEE SURGERY & SKULL SURGERY

- INSTRUMENTS FOR KNEE SURGERY**
- 245.005 Bristle Knee Retractor
 - 245.010 Bristle Knee Retractor - Clasp
 - 245.015 Manual Compression Clamp
 - 245.020 Bristle Knee Joint Retractor (Set of 3)
 - 245.025 Bristle Manual Compression Clamp (Set of 3)
 - 245.030 Clasp Knee Compression Clamp
 - 245.035 Manual Compression Clamp



MANUAL COMPRESSION CLAMP
 Code No. 245.015

- INSTRUMENTS FOR SKULL SURGERY**
- 244.005 Gigli Saw wire - Standard
 - 244.010 Gigli Saw wire - Fine (D) product
 - 244.015 Gigli Saw handle - 18"
 - 244.020 Gigli Saw handle - 24"
 - 244.025 Gigli Saw handle - 30"
 - 244.030 Gigli Saw handle with 2.5mm hole
 - 244.035 Gigli Saw handle with 3mm hole
 - 244.040 Gigli Saw handle with 3.5mm hole
 - 244.045 Gigli Saw handle with 4mm hole
 - 244.050 Gigli Saw handle with 5mm hole



GIGLI SAW HANDLE - FINER
 Code No. 244.010

Instruments for Knee Surgery & Skull Surgery
RI-93-1430
 Instruments for Knee Surgery & Skull Surgery

GENERAL INSTRUMENTS

- SKIN DRAFTING INSTRUMENTS**
- 249.005 Skin Drafting Knife - Small
 - 249.010 Skin Drafting Knife - Large
 - 249.015 Skin Drafting Knife - Extra Large
 - 249.020 Skin Drafting Knife - Super Large
 - 249.025 Skin Drafting Knife - Jumbo
 - 249.030 Skin Drafting Knife - Jumbo (S)



SKIN DRAFTING KNIFE - SMALL
 Code No. 249.005

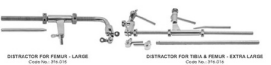

SKIN DRAFTING KNIFE - LARGE
 Code No. 249.010



SKIN DRAFTING KNIFE - EXTRA LARGE
 Code No. 249.015



SKIN DRAFTING KNIFE - SUPER LARGE
 Code No. 249.020

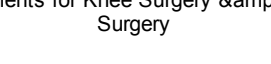

SKIN DRAFTING KNIFE - JUMBO
 Code No. 249.025



SKIN DRAFTING KNIFE - JUMBO (S)
 Code No. 249.030

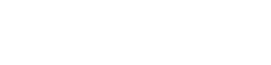

SKIN DRAFTING KNIFE - JUMBO (S)
 Code No. 249.030

Instruments for Knee Surgery & Skull Surgery
RI-93-1431
 Instruments for Knee Surgery & Skull Surgery

SPINE SURGERY - TRAUMATOLOGY & LAMINECTOMY

- TRAUMATOLOGY OF SPINE**
- 118.005 Spinal Retractor
 - 118.010 Spinal Retractor - Large
 - 118.015 Spinal Retractor - Extra Large
 - 118.020 Spinal Retractor - Jumbo
 - 118.025 Spinal Retractor - Jumbo (S)

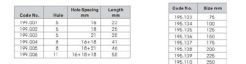

SPINAL RETRACTOR
 Code No. 118.005



SPINAL RETRACTOR - LARGE
 Code No. 118.010



SPINAL RETRACTOR - EXTRA LARGE
 Code No. 118.015



SPINAL RETRACTOR - JUMBO
 Code No. 118.020

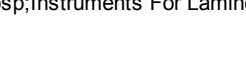

SPINAL RETRACTOR - JUMBO (S)
 Code No. 118.025



SPINAL RETRACTOR - JUMBO (S)
 Code No. 118.025



SPINAL RETRACTOR - JUMBO (S)
 Code No. 118.025

Instruments For Laminectomy
RI-93-1432
 Instruments For Laminectomy

INSTRUMENTS FOR LAMINECTOMY



Punch Forceps - Small (D)
 Code No. 397.002



Punch Forceps - Large (D)
 Code No. 397.003



Punch Forceps - Extra Large (D)
 Code No. 397.004



Punch Forceps - Jumbo (D)
 Code No. 397.005

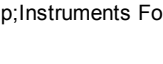

Punch Forceps - Jumbo (S)
 Code No. 397.006



Punch Forceps - Jumbo (S)
 Code No. 397.006



Punch Forceps - Jumbo (S)
 Code No. 397.006



Punch Forceps - Jumbo (S)
 Code No. 397.006

Instruments For Laminectomy
RI-93-1433
 Instruments For Laminectomy

Instruments

... INSTRUMENTS FOR LARGE FRAGMENTS

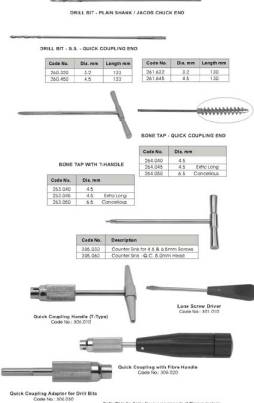

**Instruments for Large Fragments
RI-93-1434**
 Instruments for Large Fragments

BASIC INSTRUMENTS & IMPLANTS SET ... LARGE FRAGMENTS
□ INSTRUMENTS FOR LARGE FRAGMENTS

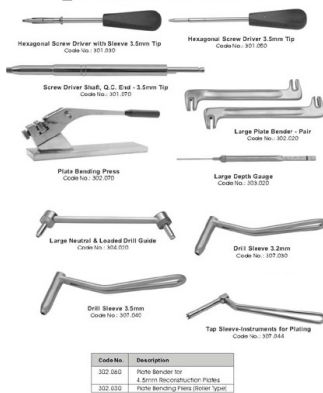

**Instruments for Large Fragments
RI-93-1435**
 Instruments for Large Fragments

... INSTRUMENTS FOR LARGE FRAGMENTS

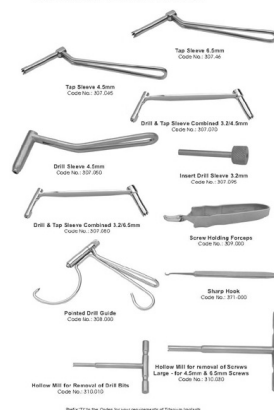

**Instruments for Large Fragments
RI-93-1436**
 Instruments for Large Fragments

... SPINE IMPLANTS & INSTRUMENTS

Length	Material	Model	Material	Model	Material	Model	Material	Model
100	SS	100-101	SS	100-102	SS	100-103	SS	100-104
120	SS	120-101	SS	120-102	SS	120-103	SS	120-104
140	SS	140-101	SS	140-102	SS	140-103	SS	140-104
160	SS	160-101	SS	160-102	SS	160-103	SS	160-104
180	SS	180-101	SS	180-102	SS	180-103	SS	180-104
200	SS	200-101	SS	200-102	SS	200-103	SS	200-104
220	SS	220-101	SS	220-102	SS	220-103	SS	220-104
240	SS	240-101	SS	240-102	SS	240-103	SS	240-104
260	SS	260-101	SS	260-102	SS	260-103	SS	260-104
280	SS	280-101	SS	280-102	SS	280-103	SS	280-104
300	SS	300-101	SS	300-102	SS	300-103	SS	300-104
320	SS	320-101	SS	320-102	SS	320-103	SS	320-104
340	SS	340-101	SS	340-102	SS	340-103	SS	340-104
360	SS	360-101	SS	360-102	SS	360-103	SS	360-104
380	SS	380-101	SS	380-102	SS	380-103	SS	380-104
400	SS	400-101	SS	400-102	SS	400-103	SS	400-104
420	SS	420-101	SS	420-102	SS	420-103	SS	420-104
440	SS	440-101	SS	440-102	SS	440-103	SS	440-104
460	SS	460-101	SS	460-102	SS	460-103	SS	460-104
480	SS	480-101	SS	480-102	SS	480-103	SS	480-104
500	SS	500-101	SS	500-102	SS	500-103	SS	500-104
520	SS	520-101	SS	520-102	SS	520-103	SS	520-104
540	SS	540-101	SS	540-102	SS	540-103	SS	540-104
560	SS	560-101	SS	560-102	SS	560-103	SS	560-104
580	SS	580-101	SS	580-102	SS	580-103	SS	580-104
600	SS	600-101	SS	600-102	SS	600-103	SS	600-104
620	SS	620-101	SS	620-102	SS	620-103	SS	620-104
640	SS	640-101	SS	640-102	SS	640-103	SS	640-104
660	SS	660-101	SS	660-102	SS	660-103	SS	660-104
680	SS	680-101	SS	680-102	SS	680-103	SS	680-104
700	SS	700-101	SS	700-102	SS	700-103	SS	700-104
720	SS	720-101	SS	720-102	SS	720-103	SS	720-104
740	SS	740-101	SS	740-102	SS	740-103	SS	740-104
760	SS	760-101	SS	760-102	SS	760-103	SS	760-104
780	SS	780-101	SS	780-102	SS	780-103	SS	780-104
800	SS	800-101	SS	800-102	SS	800-103	SS	800-104
820	SS	820-101	SS	820-102	SS	820-103	SS	820-104
840	SS	840-101	SS	840-102	SS	840-103	SS	840-104
860	SS	860-101	SS	860-102	SS	860-103	SS	860-104
880	SS	880-101	SS	880-102	SS	880-103	SS	880-104
900	SS	900-101	SS	900-102	SS	900-103	SS	900-104
920	SS	920-101	SS	920-102	SS	920-103	SS	920-104
940	SS	940-101	SS	940-102	SS	940-103	SS	940-104
960	SS	960-101	SS	960-102	SS	960-103	SS	960-104
980	SS	980-101	SS	980-102	SS	980-103	SS	980-104
1000	SS	1000-101	SS	1000-102	SS	1000-103	SS	1000-104

**Instruments For Mausmiami
RI-93-1437**
 Instruments For Mausmiami

SPINE SURGERY ... INSTRUMENTS



**Instruments For Mausmiami
RI-93-1438**
 Instruments For Mausmiami

NAILINGS ... INSTRUMENTS FOR MODIFIED TIBIAL & FEMORAL NAILS

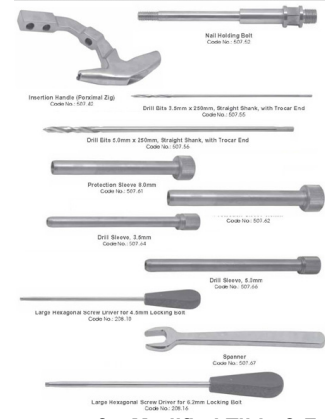

**Instruments for Modified Tibia & Femur Nails
RI-93-1441**
 Instruments for Modified Tibia & Femur Nails

Instruments

HIP PROSTHESIS

INSTRUMENTS FOR PRECISION MODULAR HIP SYSTEM



HAND TOP CAP FOR A.C.T. HIP SYSTEM

Code No.	Size	Weight	Length
175.800	30	176.118	176.118
175.805	35	176.118	176.118
175.810	40	176.118	176.118
175.815	45	176.118	176.118
175.820	50	176.118	176.118
175.825	55	176.118	176.118
175.830	60	176.118	176.118
175.835	65	176.118	176.118
175.840	70	176.118	176.118
175.845	75	176.118	176.118
175.850	80	176.118	176.118
175.855	85	176.118	176.118
175.860	90	176.118	176.118
175.865	95	176.118	176.118
175.870	100	176.118	176.118

PRIMARY INSTRUMENTS FOR MODULAR STEM

MODULAR SYSTEM RETRACTORS

PRECISION MODULAR TAPERED BEAMERS WITH HISSON FITTING

ROSE PLUS

PRECISION TOTAL HIP BRACKET/TRAIL FOR BIODIRECTIONAL STEEL COMPONENT

Instruments for Modular Hip System

RI-93-1443
& Instruments for Modular Hip System

...HIP PROSTHESIS

INSTRUMENTS FOR PRECISION MODULAR HIP SYSTEM

Code No. Description

Code No.	Description	Size mm
175.935	Precision femoral stem insert	175.935
175.936	all thread Coupling for Femoral Stem	175.936
175.937	Non Alignment Tool for Accipiter Femoral Stem Insert	175.937
175.938	Precision Bone Cement/Block Inserting Tool	175.938
175.941	175.941	

PRIMARY MODULAR SYSTEM ACETABULAR CUP/NECK TRAYS

ACETABULAR CUP TRAY

PRECISION ACETABULAR BEAMERS HEAD COMPONENTS

ACETABULAR CUP TRAY

Instruments for Modular Hip System

RI-93-1444
& Instruments for Modular Hip System

...INSTRUMENTS FOR MODIFIED TIBIAL & FEMORAL NAILS

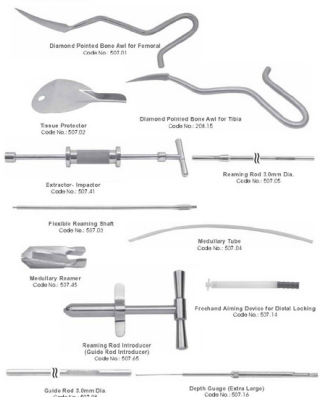

Instruments for PFN Nails

RI-93-1445
& Instruments for PFN Nails

...NAILINGS

INSTRUMENTS FOR PFN & RECON NAILS

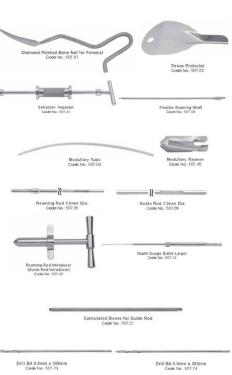

Instruments for RECON Nails

RI-93-1447
& Instruments for RECON Nails

...INSTRUMENTS FOR PFN & RECON NAILS



Instruments for RECON Nails

RI-93-1448
& Instruments for RECON Nails

SMALL FRAGMENTS IMPLANTS & INSTRUMENTS

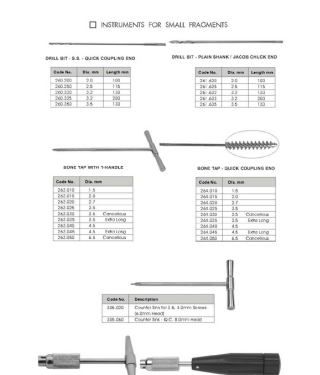

Instruments for Small Fragments

RI-93-1449
& Instruments for Small Fragments

Instruments

... SMALL FRAGMENTS INSTRUMENTS



Instruments for Small Fragments
RI-93-1450
 Instruments for Small Fragments

SMALL FRAGMENTS IMPLANTS & INSTRUMENTS

□ INSTRUMENTS FOR SMALL FRAGMENTS

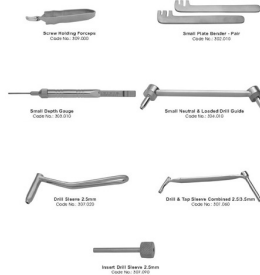

Code No.	Description
1450-01	Plate Washer for 2.0mm (approx) width Plates
1450-02	Plate Washer for 3.0mm (approx) width Plates

Instruments for Small Fragments
RI-93-1451
 Instruments for Small Fragments

NAILINGS ... INSTRUMENTS FOR UNIVERSAL TIBIAL & FEMORAL NAILS

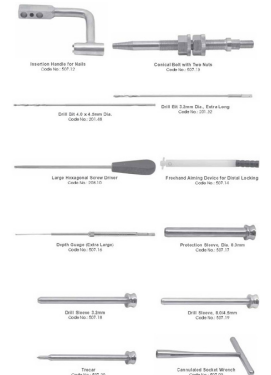

Instruments for Universal Tibia & Femoral Nails
RI-93-1454
 Instruments for Universal Tibia & Femoral Nails

GENERAL INSTRUMENTS ... PLASTER CUTTING INSTRUMENTS

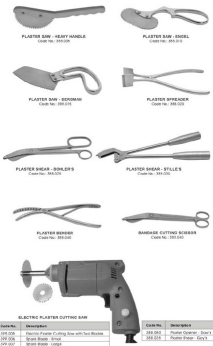

Plaster Cutting Instruments
RI-93-1455
 Plaster Cutting Instruments

Misc.Implants

MISC. NAILS, WIRES & PINS_KIRCHNER WIRE / RUSH NAILS

TREASURED CORTICAL WIRE

Length	Weight	Length
100	1.5	100
120	1.8	120
150	2.2	150
180	2.7	180
200	3.0	200

RUSH NAILS

Length	Weight	Length	Weight	Length	Weight
10	0.10	20	0.20	30	0.30
15	0.15	25	0.25	35	0.35
20	0.20	30	0.30	40	0.40
25	0.25	35	0.35	45	0.45
30	0.30	40	0.40	50	0.50
35	0.35	45	0.45	55	0.55
40	0.40	50	0.50	60	0.60
45	0.45	55	0.55	65	0.65
50	0.50	60	0.60	70	0.70
55	0.55	65	0.65	75	0.75
60	0.60	70	0.70	80	0.80
65	0.65	75	0.75	85	0.85
70	0.70	80	0.80	90	0.90
75	0.75	85	0.85	95	0.95
80	0.80	90	0.90	100	1.00
85	0.85	95	0.95		
90	0.90	100	1.00		
95	0.95				
100	1.00				

**Rush Nails
RI-93-1508
 Rush Nails**

STEINMANN PINS

Length	Weight	Length	Weight	Length	Weight
100	1.5	120	1.8	150	2.2
120	1.8	150	2.2	180	2.7
150	2.2	180	2.7	200	3.0
180	2.7	200	3.0		

CENTRAL TYPED STEINMANN PINS

Code No.	Pin No.	Length
1000	10	100
1100	11	120
1200	12	150
1300	13	180
1400	14	200

STAPLES - U TYPE

Code No.	Pin No.	Length
1000	10	100
1100	11	120
1200	12	150
1300	13	180
1400	14	200

INSTRUMENTS FOR STAPLES

Code No.	Instrument
1000	Staple Driver
1100	Staple Remover
1200	Staple Driver
1300	Staple Remover
1400	Staple Driver
1500	Staple Remover

**Staples
RI-93-1510
 Staples**

STEINMANN PINS

Length	Weight	Length	Weight	Length	Weight
100	1.5	120	1.8	150	2.2
120	1.8	150	2.2	180	2.7
150	2.2	180	2.7	200	3.0
180	2.7	200	3.0		

CENTRAL TYPED STEINMANN PINS

Code No.	Pin No.	Length
1000	10	100
1100	11	120
1200	12	150
1300	13	180
1400	14	200

STAPLES - U TYPE

Code No.	Pin No.	Length
1000	10	100
1100	11	120
1200	12	150
1300	13	180
1400	14	200

INSTRUMENTS FOR STAPLES

Code No.	Instrument
1000	Staple Driver
1100	Staple Remover
1200	Staple Driver
1300	Staple Remover
1400	Staple Driver
1500	Staple Remover

**Steinmann Pins
RI-93-1511
 Steinmann Pins**

Special Pins - S.S.

Length	Weight	Length	Weight
100	1.5	120	1.8
120	1.8	150	2.2
150	2.2	180	2.7
180	2.7	200	3.0

PROXIMAL LATERAL PLATE

Code No.	Pin No.	Length
1000	10	100
1100	11	120
1200	12	150
1300	13	180
1400	14	200

DISTAL TIBIAL PLATE

Code No.	Pin No.	Length
1000	10	100
1100	11	120
1200	12	150
1300	13	180
1400	14	200

**Straight Side Connector
RI-93-1512
 Straight Side Connector**

Nails

NAILINGS ... INTRAMEDULLARY SUPRA CONDYLAR NAIL

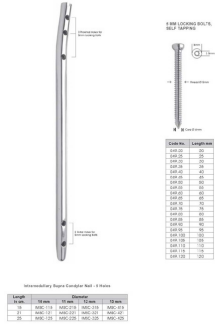

Locking Bolt, 5mm for Supra Condylar Nails

RI-93-1608

 Locking Bolt, 5mm for Supra Condylar Nails

NAILINGS ... PROXIMAL FEMORAL & RECON NAILS

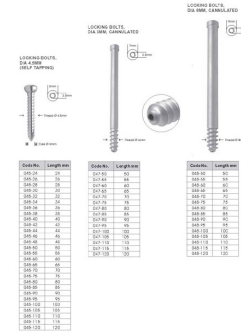

Locking Bolt, Cannulated
RI-93-1609

 Locking Bolt, Cannulated 6mm & 8mm
6mm,8mm,



ENTERPRISE

CONTACT US

Rohtas Enterprise

Address:

Nzam Abad Shafi Tha Patha Near Al noor Marriage,
Hall Bagowal Road, Sialkot-51310, Pakistan

Phone : +92-52-3543222, 3543223, 3543224

Phone : +92-3543227,3543228

Fax : +92-52-4568882

E-mail : info@rohtasentp.com

