



Rohtas

ENTERPRISE



SURGICAL INSTRUMENTS

PRODUCTS CATALOGUE

www.rohtasentp.com

Diagnostics



Buck
RI-1-101-18
Percussion Hammer
18.5 cm,



Buck
RI-1-102-18
20cm,

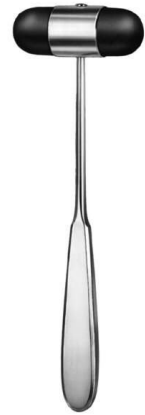

Dejerine
RI-1-103-20
Percussion Hammer
20cm,



Dejerine
RI-1-104-21
Percussion Hammer
21cm,



Taylor Mod. USA
RI-1-105-20
Percussion Hammer
20cm,



Wartenberg
RI-1-106-19
Pinwheel
18cm,

Diagnostics



Pinard
RI-1-107-18
Stethoscope
18 cm,



Pinard
RI-1-108-15
Stethoscope
15cm,

Anesthesia



Magill

RI-2-101-15

Catheter Introducing Forceps
14.5 cm, 20 cm, 25 cm,



Miller

RI-2-102-00

Laryngoscope Sets



Miller-Baby

RI-2-103-00

Laryngoscope Sets



Miller

RI-2-104-00

Laryngoscope Blade
Fig. 0, Fig. 1, Fig. 2, Fig. 3, Fig. 4,



Guedel-Negus

RI-2-105-00

Laryngoscope Sets
Fig. 2, Fig. 3, Fig. 4,



Guedel-Negus

RI-2-106-00

Laryngoscope Sets
Fig. 1, Fig. 2, Fig. 3, Fig. 4,

Anesthesia



Guedel-Negus
RI-2-107-01

Laryngoscope Blades
Fig. 1, Fig. 2, Fig. 3, Fig. 4,



McIntosh
RI-2-108-00



McIntosh
RI-2-109-00

Laryngoscope Blades
Fig. 0, Fig. 1, Fig. 2, Fig. 3, Fig. 4,



McIntosh
RI-2-110-00

Laryngoscope Sets
Fig. 1, Fig. 2, Fig. 3, Fig. 4,



Foregger
RI-2-111-01

Laryngoscope Blades
Fig. 1, Fig. 2, Fig. 3, Fig. 4,



Battery Handle
RI-2-112-00
Battery Handle

Anesthesia



McIntosh
RI-2-114-00

Laryngoscope Sets fiber optic
Fig. 1, Fig. 2, Fig. 3,



McIntosh
RI-2-115-00

Laryngoscope Sets fiber optic
Fig. 1, Fig. 2, Fig. 3,



McIntosh
RI-2-116-00

Laryngoscope Sets fiber optic
Fig. 1, Fig. 2, Fig. 3,



McIntosh
RI-2-113-00

Laryngoscope Sets
Fig. 1, Fig. 2, Fig. 3, Fig. 4,

Trocars



Universal
RI-3-101-04
Trocar
14 cm,



Nelson
RI-3-102-07
Trocar
20 cm,



Lichtwitz
RI-3-103-19
Antrum Trocar
18.5 cm,



Adson
RI-3-104-21
Suction Cannula
20 cm,



Frazier
RI-3-105-10
Suction Cannula
24 cm,



Frazier
RI-3-106-06
Suction Cannula
19.5 cm,

Trocars



Poppen
RI-3-107-06
 Suction Cannula
 18 cm,



Luer
RI-3-108-30
 Suction Tube working length 110 mm



Yasargil
RI-3-109-15
 Suction Tube working length 150 mm with
 Luer hub
 21.5 cm,



Yankauer
RI-3-110-27
 Suction Tube complete with suction tip and
 connector
 31 cm,



Yankauer
RI-3-111-00
 Suction Tube
 31 cm, 15 cm, 2.5 cm, 10 cm,



Poole
RI-3-112-22
 Suction Tube
 22 cm,

Trocars



Poole
RI-3-113-22
Suction Tube
22.5 cm,



Nuboer
RI-3-114-21
Suction Tube
21 cm,



Nuboer
RI-3-115-21
Suction Tube
21 cm,



Quinke
RI-3-116-10
Lumbar Puncture Needle



Tuohy
RI-3-117-12
Lumbar Puncture Needle Luer Lock
connection with special tip



Verres
RI-3-118-20
Insufflation Cannula Luer Lock connection
15 cm,

Trocars



Verres

RI-3-119-20

Insufflation Cannula Luer Lock connection
17 cm,

Suture



Kalt
RI-4-105-14
 Needle Holder
 13.5 cm,



Barraquer-Troutman
RI-4-106-10
 Micro Needle Holder
 10 cm, 10.5 cm,



Arruga
RI-4-107-14
 Micro Needle Holder
 13.5 cm,



Barraquer-Troutman
RI-4-108-10
 Micro Needle Holder
 10.5 cm, 11.5 cm,



Barraquer
RI-4-109-11
 Micro Needle Holder
 11.5 cm, 13.5 cm, 14 cm,



Barraquer
RI-4-110-13
 Micro Needle Holder
 13.5 cm,

Suture



Castroviejo-Fino
RI-4-111-01
 Micro Needle Holder
 13 cm,



Castroviejo-Fino
RI-4-112-01
 Micro Needle Holder
 13 cm,



Castroviejo-Fino
RI-4-113-01
 very delicate jaw with lock
 13 cm,



Castroviejo
RI-4-114-14
 Micro Needle Holder with lock
 14 cm,



Castroviejo
RI-4-115-14
 Micro Needle Holder
 14 cm,



Castroviejo
RI-4-121-14
 Micro Needle Holder with lock
 14 cm,

Suture



Castroviejo
RI-4-122-14
Micro Needle Holder
14 cm,



Castroviejo
RI-4-124-13
Micro Needle Holder with lock
12 cm,



Arruga
RI-4-123-16
Needle Holder delicate
16 cm,



Castroviejo
RI-4-125-12
Micro Needle Holder with lock
12 cm,



Derf
RI-4-126-12
Needle Holder
12 cm, 13 cm,

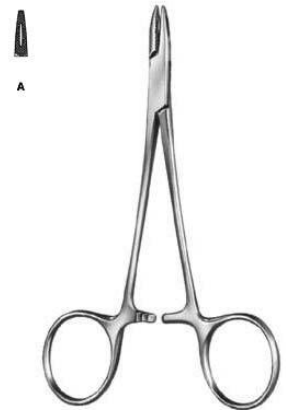

Collier
RI-4-127-12
Needle Holder
12.5 cm,

Suture



Webster
RI-4-128-13
Needle Holder
13 cm,



Halsey
RI-4-129-13
Needle Holder
13.5 cm,



Neivert
RI-4-130-13
Needle Holder
12.5 cm,



Hegar-Baumgartner
RI-4-131-14
Needle Holder
14.5 cm,



Crile-Murray
RI-4-133-15
Needle Holder
15 cm,



Crile-Wood
RI-4-134-15
Needle Holder
15 cm,

Suture



Adson

RI-4-140-18

Needle Holder one fenestrated jaw
18 cm,



Metzenbaum

RI-4-141-18

Needle Holder one grooved and fenestrated
jaw
18.5 cm,



M. G. Hospital

RI-4-142-17

Needle Holder
17.5 cm,

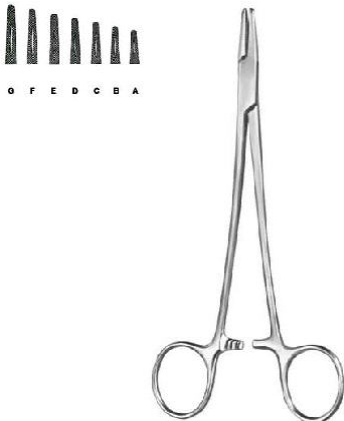

Mayo-Hegar

RI-4-143-14

Needle Holder
14.5 cm, 16 cm, 18.5 cm, 20.5 cm, 24 cm, 26.5
cm,



Mayo-Hegar

RI-4-144-16

Needle Holder
16 cm, 18.5 cm, 20.5 cm,

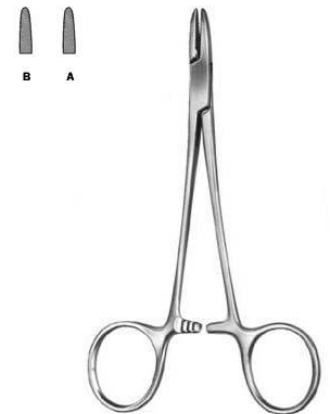

Brown

RI-4-145-13

Needle Holder
13 cm, 18 cm,

Suture

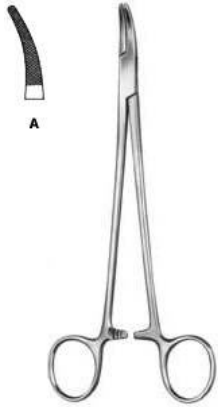

Heaney
RI-4-146-21
Needle Holder
20.5 cm,

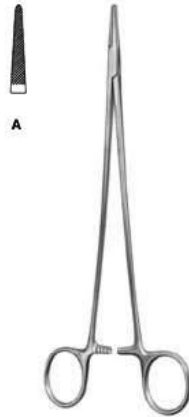

Jamison
RI-4-147-23
Needle Holder
23.5 cm,



Masson
RI-4-148-27
Needle Holder
26.5 cm,

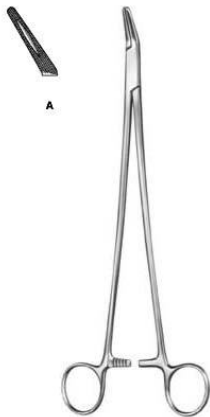

Finochietto
RI-4-149-27
Needle Holder
26.5 cm,



Wangensteen
RI-4-150-27
Needle Holder
26.5 cm,

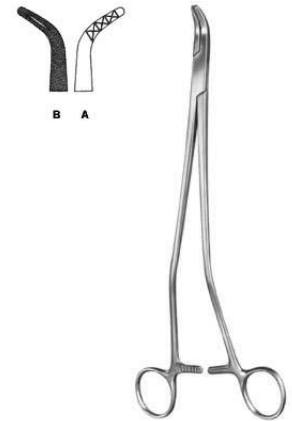

Johnson
RI-4-151-27
Needle Holder
27 cm,

Suture

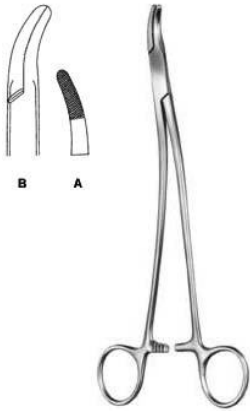

Stratte
RI-4-152-23
 Needle Holder
 23 cm,

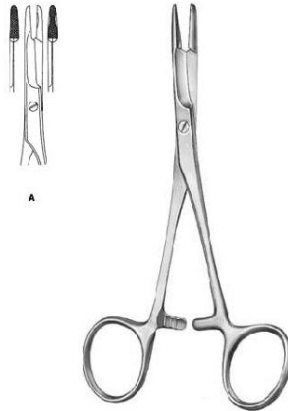

Olsen-Hegar
RI-4-153-14
 Needle Holder
 14 cm,

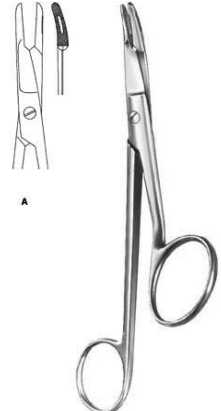

Gillies
RI-4-154-16
 Needle Holder
 16 cm,



Crile
RI-4-155-15
 Needle Holder
 15 cm,



Mathieu
RI-4-156-14
 Needle Holder
 14 cm, 17 cm, 20 cm,



Mathieu
RI-4-157-14
 Needle Holder
 14 cm, 16.5 cm,

Suture

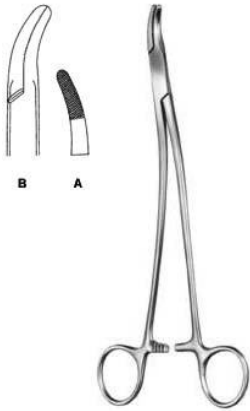

Stratte
RI-4-152-23
 Needle Holder
 23 cm,

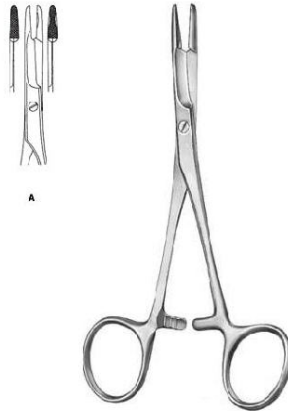

Olsen-Hegar
RI-4-153-14
 Needle Holder
 14 cm,

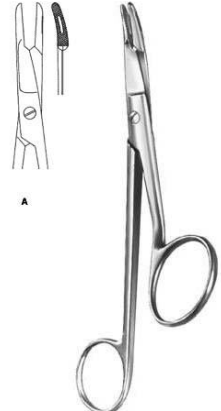

Gillies
RI-4-154-16
 Needle Holder
 16 cm,



Crile
RI-4-155-15
 Needle Holder
 15 cm,



Mathieu
RI-4-156-14
 Needle Holder
 14 cm, 17 cm, 20 cm,



Mathieu
RI-4-157-14
 Needle Holder
 14 cm, 16.5 cm,

Suture



Toennis
RI-4-158-18
 Needle Holder
 18.5 cm,



Lichtenberg
RI-4-159-20
 Needle Holder
 20 cm,



RI-4-160-16
 Micro Needle Holder
 16 cm,

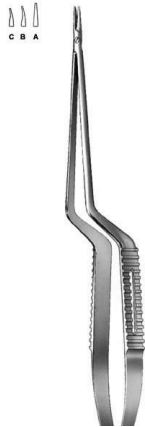

RI-4-161
 Micro Needle Holder
 23 cm, 19 cm,



Hepp-Scheidel
RI-4-162-18
 Micro Needle Holder smooth jaw
 18 cm,



Webster
RI-4-163-13
 Needle Holder with automatic release ratchet
 also for lefthanders
 13 cm, 15 cm,

Suture



RI-4-164-15

Micro Needle Holder
15 cm, 18 cm, 21 cm, 23 cm,



JABOMA

RI-4-165-18

Micro Needle Holder
18 cm,



Castroviejo

RI-4-166

Micro Needle Holder
14.5 cm, 18 cm, 21.5 cm,



Arruga

RI-4-167

Needle Holder
16 cm,



Castroviejo

RI-4-168-13

Micro Needle Holder
12.5 cm,



Barraquer

RI-4-169-13

Micro Needle Holder
13 cm,

Suture



Barraquer
RI-4-170-13
 Micro Needle Holder
 13 cm,



Webster
RI-4-171-13
 Needle Holder
 13 cm,



Derf
RI-4-173-12
 Needle Holder
 12 cm,

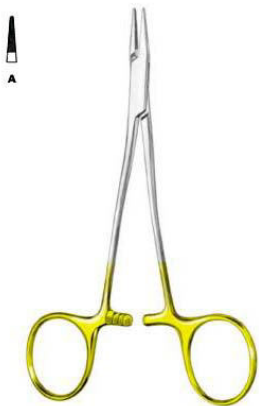

Kilner
RI-4-172-13
 Needle Holder
 13 cm,



Hegar-Baumgartner
RI-4-174-13
 Needle Holder
 13 cm, 14.5 cm,



Halsey
RI-4-175-12
 Needle Holder
 13 cm, 12 cm,

Suture



Crile-Wood
RI-4-176-15
 Needle Holder
 15 cm,



Sarot
RI-4-177-18
 Needle Holder
 18 cm, 20 cm, 26 cm,

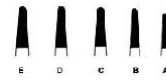

Mayo-Hegar
RI-4-178-16
 Needle Holder standard profile
 16 cm, 18 cm, 20 cm, 24 cm, 26 cm, 30 cm,



Heaney
RI-4-179-20
 Needle Holder
 20 cm, 24 cm, 26 cm,

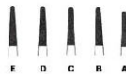

DeBakey
RI-4-180-18
 Needle Holder delicate pattern mini profile
 18 cm, 20 cm, 23 cm, 26 cm, 31 cm,



Masson
RI-4-181-27
 Needle Holder
 26.5 cm,

Suture

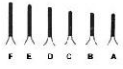

Ryder (Martin)
RI-4-182-13

Needle Holder
12.5 cm, 15 cm, 18 cm, 20 cm, 23 cm, 26 cm,

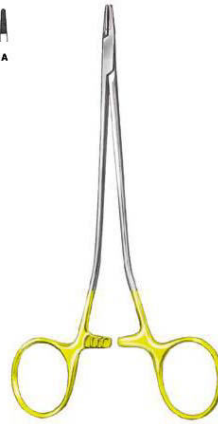

Martin
RI-4-183-15

Needle Holder mini profile elastic type
15 cm, 17 cm, 20 cm,



Wangensteen
RI-4-184-27

Needle Holder standard profile
27 cm,



Hegar-Vascular
RI-4-185-14

Needle Holder micro profile
14 cm, 18.5 cm, 20.5 cm, 23 cm,

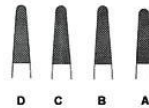

Bozemann
RI-4-186-20

Needle Holder standard profile
20.5 cm, 24 cm, 26.5 cm, 29 cm,



Hegar
RI-4-187-20

Needle Holder standard profile
20 cm, 23.5 cm,

Suture

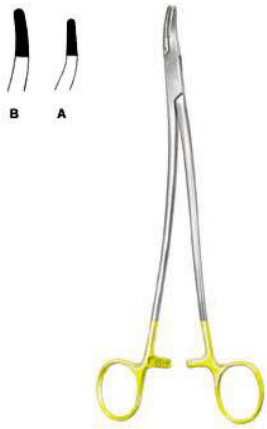

Stratte

RI-4-188-22

Needle Holder standard profile
23 cm,



Microvascular

RI-4-189-00

Needle Holder slender pattern micro profile
14 cm, 17.5 cm, 20 cm, 23 cm,



Mathieu

RI-4-190-14

Needle Holder
14 cm, 17 cm, 20 cm,



Mathieu

RI-4-191-14

Needle Holder
14 cm, 17 cm, 20 cm,



Mathieu

RI-4-192-17

Needle Holder standard profile with interior
ratchet
17 cm, 20 cm, 23 cm,



Toennis

RI-4-193-18

Needle Holder
18.5 cm,

Suture



Lichtenberg
RI-4-194-20

Needle Holder lightweight model standard profile
20 cm,



Langenbeck
RI-4-195-18

Needle Holder
18 cm, 20.5 cm, 23 cm,



Zweifel
RI-4-196-20

Needle Holder with hinged ratchet standard profile
20.5 cm, 23 cm,



Reverdin
RI-4-197-15

Reverdin Needle short
14.5 cm Fig. 1, 14.5 cm Fig. 2, 14.5 cm Fig. 3, 14.5 cm Fig. 4,

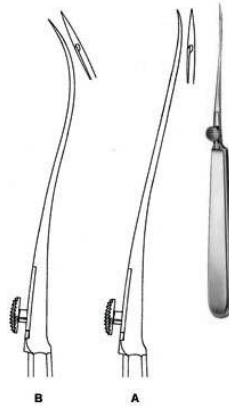

Reverdin
RI-4-198-19

Reverdin Needle medium
19.5 cm Fig. 1, 19.5 cm Fig. 2, 19.5 cm Fig. 3, 19.5 cm Fig. 4,

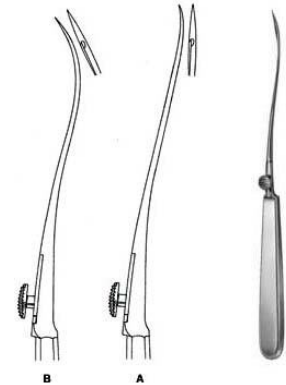

Reverdin
RI-4-199-23

Reverdin Needle long
23 cm Fig. 1, 23 cm Fig. 2, 23 cm Fig. 3, 23 cm Fig. 4,

Suture

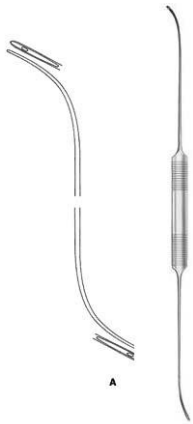

Schmieden-Dick
RI-4-201-01
 Ligature Needle malleable
 29 cm,

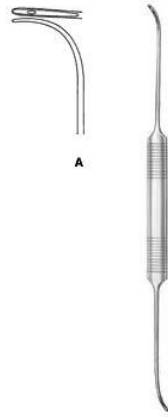

Schmieden
RI-4-202-21
 Ligature Needle
 24 cm,



RI-4-203-20
 Ligature Needle malleable
 20.5 cm,

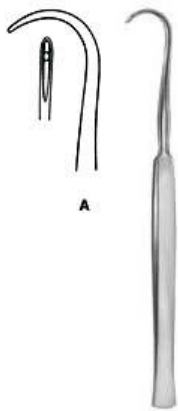

Cooper
RI-4-204-19
 Ligature Needle
 18.5 cm,



Kronecker
RI-4-205-13
 Ligature Needle delicate for right hand
 12.5 cm,

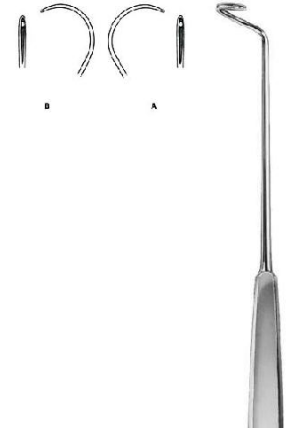

Deschamps
RI-4-206-24
 Ligature Needle blunt for right hand
 24 cm,

Suture

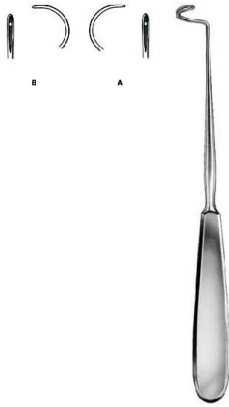

Deschamps
RI-4-207-20

Ligature Needle blunt for right hand
20 cm,

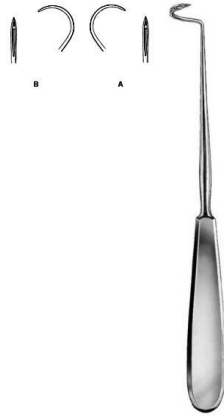

Deschamps
RI-4-208-20

Ligature Needle sharp for right hand
20 cm,

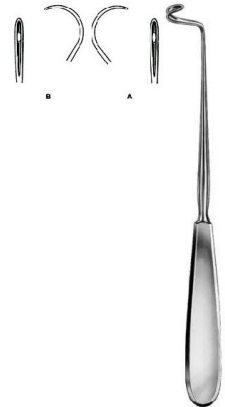

Deschamps
RI-4-209-21

Ligature Needle blunt for right hand
20 cm,

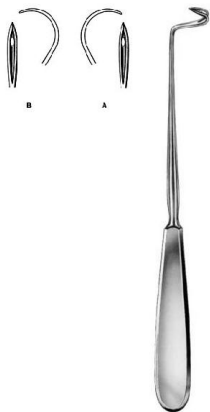

Deschamps
RI-4-210-21

Ligature Needle sharp for right hand
20 cm,

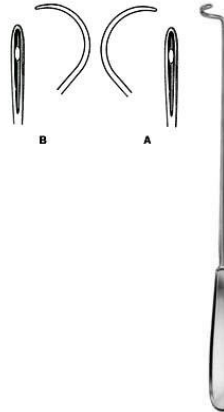

Deschamps
RI-4-211-27

Ligature Needle blunt for right hand
27 cm,

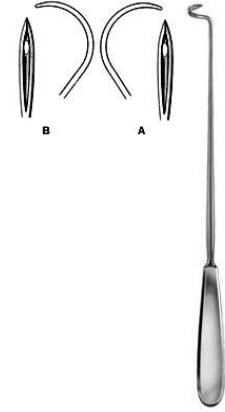

Deschamps
RI-4-212-27

Ligature Needle sharp for right hand
27 cm,

Suture

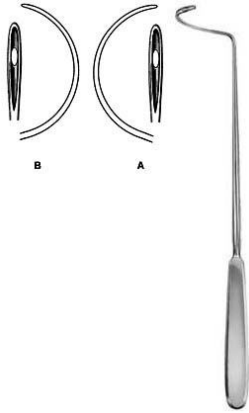

Deschamps
RI-4-213-28
Ligature Needle blunt for right hand
28 cm,

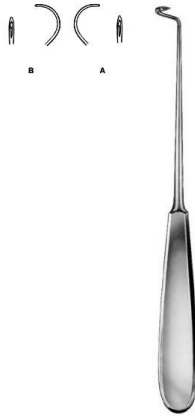

Deschamps
RI-4-214-20
Ligature Needle sharp for right hand
20 cm,



Deschamps
RI-4-215-20
Ligature Needle blunt for right hand
20 cm,



Deschamps
RI-4-216-20
Ligature Needle blunt for right hand
21 cm,

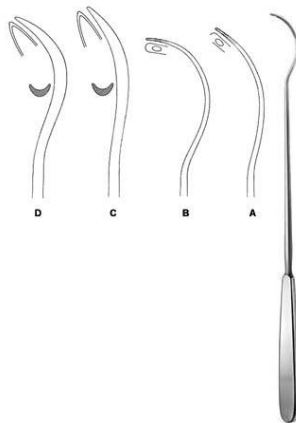

Brunner
RI-4-217-30
Ligature Needle
21 cm,



Kirschner
RI-4-218-25
Ligature Conductor
25.5 cm,

Suture

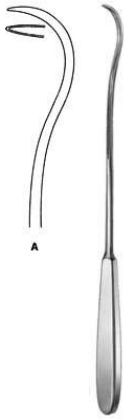

RI-4-219-28
Ligature Conductor
28 cm,



Modell Wien
RI-4-220-23
Ligature Catcher
23.5 cm,



Michel
RI-4-221-12
Clip Applying Forceps
12 cm,



Hegenbarth
RI-4-222-12
Clip Applying Forceps
12 cm,

Scalpels



RI-5-101-01

Dissecting Knife with metal handle
15 cm, 15.5 cm, 16 cm, 17 cm,



RI-5-102-10

Autopsy Knife
25.5 cm,

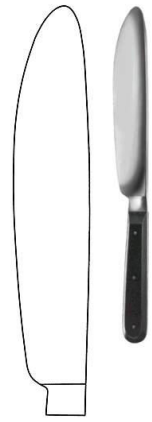

Walb

RI-5-104-17

Post Mortem Knife

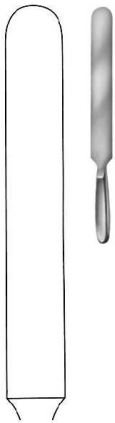

Virchow

RI-5-105-20

Brain Knife with hollow handle
28.5 cm, 33.5 cm, 38 cm,



RI-5-108-04

Scalpel Handle solid
13.5 cm,



RI-5-109-34

Scalpel Handle
16 cm,

Scalpels



RI-5-110-41
Scalpel Handle solid, long
21 cm,



RI-5-111-45
Scalpel Handle
21 cm,



Collin
RI-5-112-08
Scalpel Handle with hollow handle
13.5 cm,



Collin
RI-5-113-09
Scalpel Handle with hollow handle
14.5 cm,



RI-5-114-03
Scalpel Handle solid
12 cm,



RI-5-115-04
Scalpel Handle
12 cm,

Scalpels



RI-5-116-05
Scalpel Handle
12 cm,



RI-5-117-31
Scalpel Handle solid, long
21.5 cm,

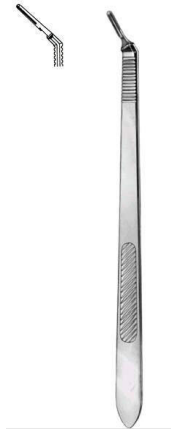

RI-5-118-35
Scalpel Handle
21 cm,



RI-5-119-07
Scalpel Handle solid
16 cm,



RI-5-120-71
Scalpel Handle solid short
12.5 cm,



RI-5-121-03
Scalpel Handle with round hollow handle
15.5 cm,

Scalpels



RI-5-127-16

Amputation Knife with hollow handle
29 cm,



RI-5-128-19

Amputation Knife with hollow handle
32.5 cm,



Catlin

RI-5-129-16

Interosseous Knife with hollow handle
29cm,



RI-5-130-06

Resection Knife solid handle, dissecting end
18 cm,



Langenbeck

RI-5-131-05

Resection Knife
18 cm,



Langenbeck

RI-5-132-05

Resection Knife
18 cm,

Scalpels



RI-5-133-00

Razor Knife hollow blades on both sides
cutting length 75mm



Schink

RI-5-134-00

Dermatome complete with 2 skin fixing
plates and one blade
31 cm,



Schink

RI-5-135-01

Spare Blade spare blade for KE-05-134-00



Schink

RI-5-136-02

Skin Fixing Plate for KE-05-134-00

Scissors



Standard BL / BL Straight

RI-5-201-13

Operating Scissor Special Price: \$1.25
12 cm, 13 cm, 14.5 cm, 16.5 cm, 18.5 cm, 20.5 cm,



Standard SH / BL STR

RI-5-202-13

Operating Scissors
12 cm, 13 cm, 14.5 cm, 16.5 cm, 18.5 cm, 20.5 cm,



Standard SH / SH STR

RI-5-204-13

Operating Scissors
12 cm, 13 cm, 14.5 cm, 16.5 cm,



Standard BL / BL Curved

RI-5-205-13

Operating Scissors
12 cm, 13 cm, 14.5 cm, 16.5 cm, 18.5 cm, 20.5 cm,



Standard SH / BL Curved

RI-5-206-13

Operating Scissors
12 cm, 13 cm, 14.5 cm, 16.5 cm, 18.5 cm, 20.5 cm,



Standard SH / SH Curved

RI-5-207-13

Operating Scissors
12 cm, 13 cm, 14.5 cm, 16.5 cm,

Scissors



Standard BL / BL Curved
RI-5-208-14
Operating Scissors delicate
14.5 cm,



Incision Scissor
RI-5-209-14
Operating Scissor
14.5 cm,



Deaver
RI-5-210-14
Operating Scissors



Mayo
RI-5-211-15
Dissecting Scissors
14.5 cm, 15 cm, 17 cm, 23.5 cm, 14.5 cm, 15
cm, 17 cm, 23.5 cm,



Mayo
RI-5-212-23
Dissecting Scissors
23 cm, 22.5 cm, 28 cm,



Mayo-Harrington
RI-5-213-22
Dissecting Scissors
23 cm, 22.5 cm, 28 cm,

Scissors

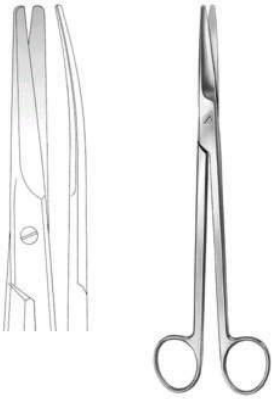

Mayo-Harrington
RI-5-214-22

Dissecting Scissors cur.
22.5 cm, 28 cm, 23 cm,

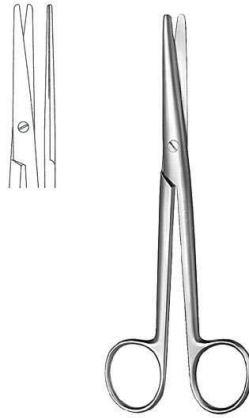

Mayo-Stille
RI-5-215-17

Dissecting Scissors str.
15 cm, 17 cm,

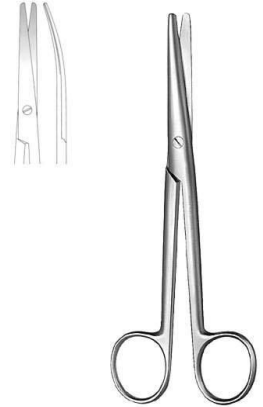

Mayo-Stille
RI-5-216-15

Dissecting Scissors cur.
15 cm, 17 cm,

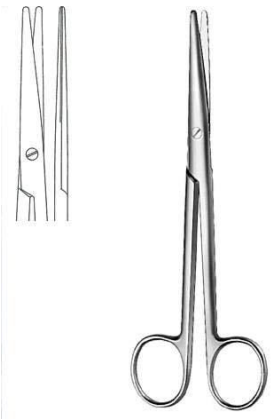

Mayo-Stille
RI-5-217-19

Dissecting Scissors str.
16 cm, 19.5 cm, 21.5 cm,

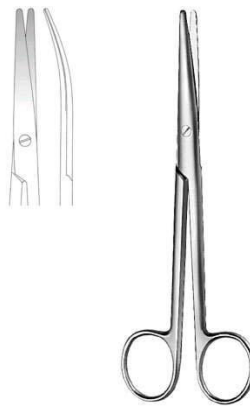

Mayo-Stille
RI-5-218-16

Dissecting Scissors cur.
16 cm, 19.5 cm, 21.5 cm,



Mayo-Noble
RI-5-219-17

Gynecological Scissors
16.5 cm,

Scissors



Sims

RI-5-220-23

Gynecological Scissors str.
20 cm, 23 cm,



Sims

RI-5-221-20

Gynecological Scissors cur.
20 cm, 23 cm,



Kelly

RI-5-222-16

Operating Scissors
16 cm,



Doyen

RI-5-223-17

Gynecological Scissors
18.5 cm,



Sims-Siebold

RI-5-224-24

Gynecological Scissors
24.5 cm,



Sims-Siebold

RI-5-225-24

Gynecological Scissors
24.5 cm,

Scissors

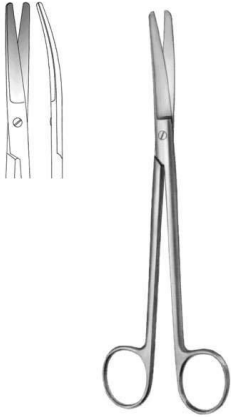

Wertheim
RI-5-226-23
Gynecological Scissors
20 cm, 23 cm,



Metzenbaum
RI-5-227-11
Dissecting Scissors
11.5 cm,



Metzenbaum
RI-5-228-14
Dissecting Scissors
14.5 cm,



Metzenbaum
RI-5-229-15
Dissecting Scissors
15.5 cm,

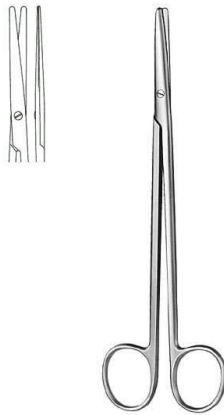

Metzenbaum-Nelson
RI-5-230-20
Dissecting Scissors
18 cm, 20.5 cm, 23 cm, 26 cm, 28.5 cm, 31 cm,

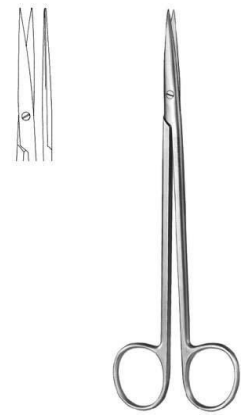

Metzenbaum-Nelson
RI-5-231-20
Dissecting Scissors
18 cm, 20.5 cm,

Scissors

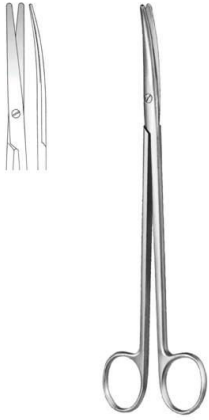

Metzenbaum-Nelson
RI-5-232-20

Dissecting Scissors
18 cm, 20.5 cm, 23 cm, 26 cm, 28.5 cm, 31 cm,



Metzenbaum
RI-5-233-14

Dissecting Scissors toothed
14.5 cm,



Nerve Operating Scissor
RI-5-234-15

Dissecting Scissors
15.5 cm,

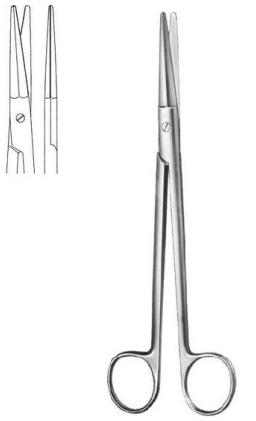

Gorney

RI-5-235-19

Face-lift Scissors str.
12.5 cm, 19.5 cm,

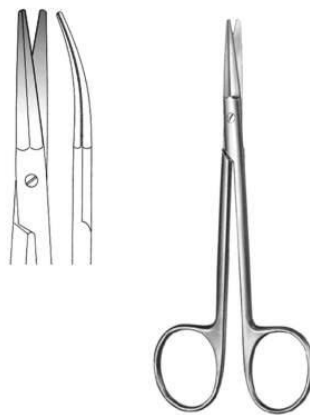

Gorney

RI-5-236-19

Face-lift Scissors cur.
19.5 cm,



Aston

RI-5-237-17

Face-lift Scissors
17 cm,

Scissors



Lexer
RI-5-238-16
Dissecting Scissors
16 cm,



Cinelli
RI-5-239-14
Nasal Scissors
11.5 cm, 14 cm,



Thorek
RI-5-240-19
Dissecting Scissors
18.5 cm,



Lexer-Baby
RI-5-241-10
Dissecting Scissors
10 cm,



Lexer-Fino
RI-5-242-16
Delicate Dissecting Scissors slender pattern
16.5 cm,



Metzenbaum-Fino
RI-5-243-14
Delicate Dissecting Scissors slender pattern
14.5 cm,

Scissors



Metzenbaum-Fino
RI-5-244-14
Delicate Dissecting Scissors
14.5 cm,



Metzenbaum-Fino
RI-5-245-14
Delicate Dissecting Scissors
14.5 cm,



Metzenbaum-Fino
RI-5-246-14
Delicate Dissecting Scissors
14.5 cm,

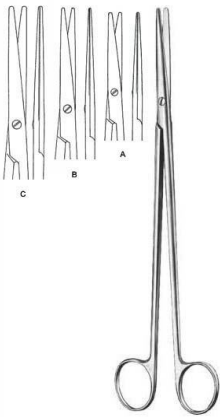

Metzenbaum-Fino
RI-5-247-18
Delicate Dissecting Scissors slender pattern
18 cm, 20 cm, 23 cm,

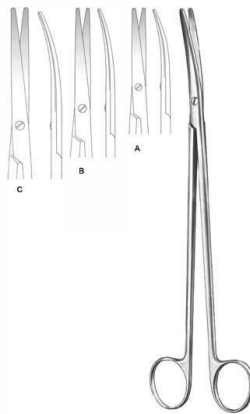

Metzenbaum-Fino
RI-5-248-18
Delicate Dissecting Scissors slender pattern
18 cm, 20 cm, 23 cm,

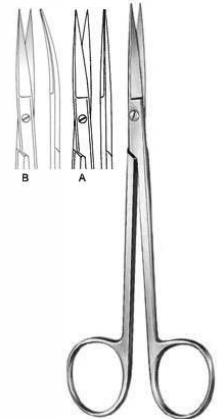

Sanvenero
RI-5-250-14
Operating Scissors
14 cm,

Scissors

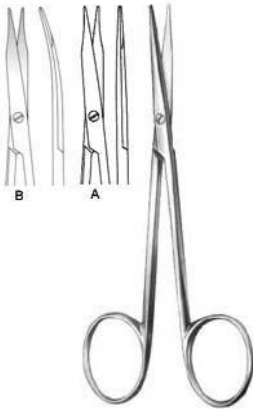

RI-5-251-11
Fine Operating Scissors
11.5 cm,

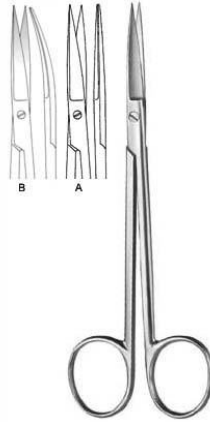

Joseph
RI-5-252-14
Operating Scissors
14.5 cm,

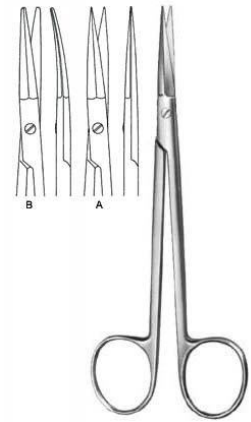

Peck-Joseph
RI-5-253-14
Face-lift Scissors
14.5 cm,

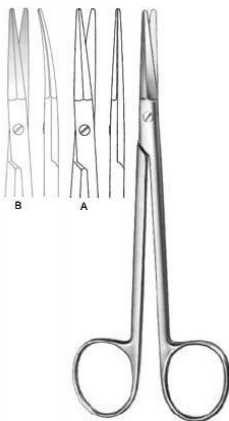

Peck-Joseph
RI-5-254-14
Face-lift Scissors
14.5 cm,



Shea Vein Graft
RI-5-255-12
Dissecting Scissors
12 cm,

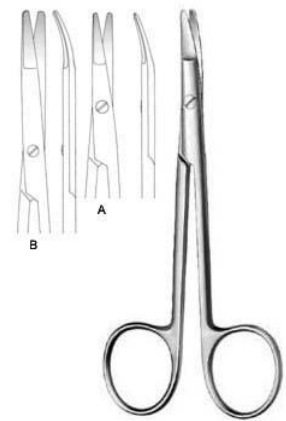

Kilner
RI-5-256-12
Dissecting Scissors
12 cm, 15 cm,

Scissors

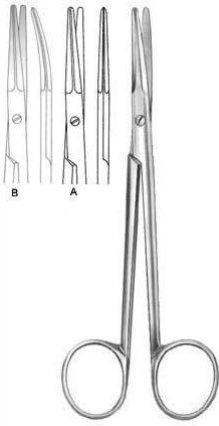

RI-5-257-14
Dissecting Scissors
14.5 cm,

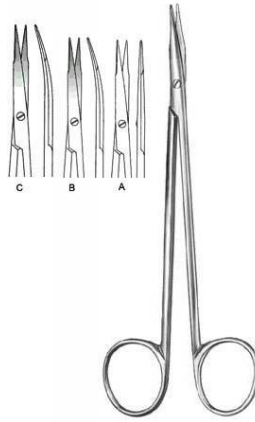

Reynolds
RI-5-258-15
Dissecting Scissors
15.5 cm, 18 cm,



Jameson
RI-5-259-14
Dissecting Scissors
15.5 cm,



Jameson
RI-5-260-14
Dissecting Scissors
15.5 cm,



RI-5-261-19
Vascular Scissors
19 cm,



RI-5-262-24
Vascular Scissors fine, short blades
19 cm, 25.5 cm,

Scissors

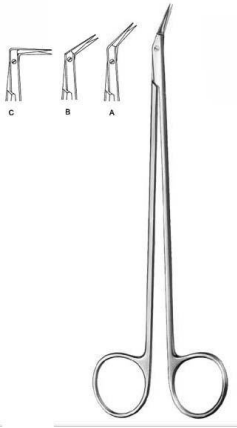

Diethrich
RI-5-263-25

Vascular Scissors
19 cm, 18.5 cm, 17.5 cm,

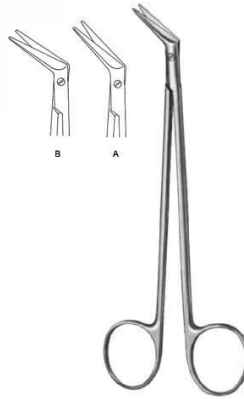

DeBaKey
RI-5-264-45

Vascular Scissors
16.5 cm, 16 cm,

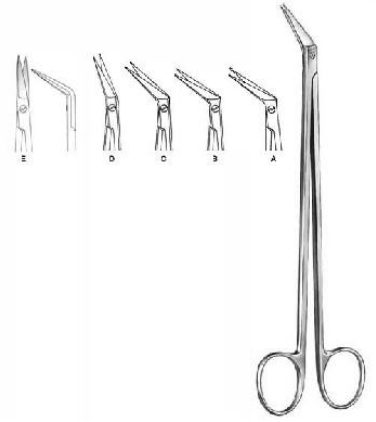

Potts-Smith
RI-5-265-19

Vascular Scissors
18 cm, 18.5 cm, 19 cm,



Coronary Scissors
RI-5-266-25

Cardiovascular Surgery Scissor
18 cm,



Coronary Scissors
RI-5-267-45

Cardiovascular Surgery Scissors
18 cm,



Coronary Scissors
RI-5-268-60

Cardiovascular Surgery Scissor
18 cm,

Scissors



Coronary Scissors
RI-5-269-90

Cardiovascular Surgery Scissor
18 cm,



Coronary Scissors
RI-5-270-00

Cardiovascular Surgery Scissor
18 cm,



Coronary Scissors
RI-5-271-00

Cardiovascular Surgery Scissor
18 cm,



Coronary Scissors
RI-5-272-25

Cardiovascular Surgery Scissor
18 cm,



Coronary Scissors
RI-5-273-45

Cardiovascular Surgery Scissor
18 cm,



Coronary Scissors
RI-5-274-90

Cardiovascular Surgery Scissor
18 cm,

Scissors



Schmieden-Taylor
RI-5-275-17
Dura Scissors
15 cm,



Strully
RI-5-276-22
Neurosurgical Scissors
22.5 cm,



Toennis-Adson
RI-5-277-17
Dissecting Scissors
17.5 cm,



Good
RI-5-279-19
Tonsil Scissors
19.5 cm,



Fomon
RI-5-282-15
Nasal Scissors
15 cm,



Cottle
RI-5-283-16
Nasal Scissors
16 cm,

Scissors



Modell USA
RI-5-290-10
Umbilical Scissors
10.5 cm,



Busch
RI-5-292-16
Umbilical Scissors
16 cm,



Goldmann-Fox
RI-5-293-13
Gum Scissors
13 cm,



Wagner
RI-5-294-12
Operating Scissors
12 cm,

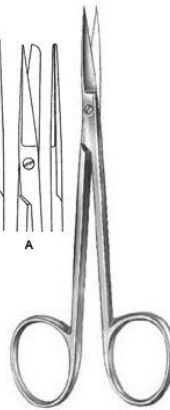
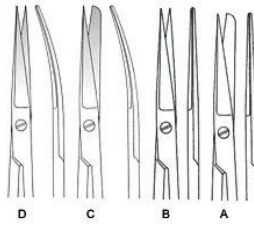

RI-5-295-12
Operating Scissors small model
12 cm,



La Grange
RI-5-296-11
Gum Scissors S-shaped
11.5 cm,

Scissors



RI-5-297-11
Dissecting Scissors delicate
11.5 cm,



Locklin
RI-5-298-16
Gum Scissors
16 cm,



Locklin
RI-5-299-16
Gum Scissors
16 cm,



RI-5-300-08
Operating Scissors very delicate
9 cm,

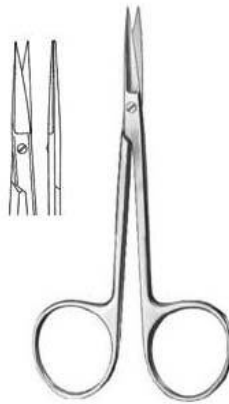

RI-5-301-10
Iris Scissors
9 cm, 10 cm,

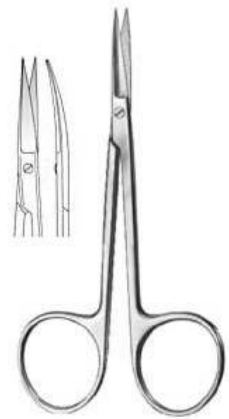

RI-5-302-10
Iris Scissors extra flat blades
10 cm,

Scissors



RI-5-303-10
Iris Scissors extra flat blades
10 cm,



Bonn
RI-5-304-09
Iris Scissors



Dean
RI-5-278-17
Tonsil Scissors
17.5 cm,



Spencer Scissor
RI-0-

Dressing & Tissue Forceps



Standard
RI-5-401-10

Dressing Forceps
10.5 cm, 11.5 cm, 13 cm, 14.5 cm, 16 cm, 18 cm, 20 cm, 23 cm, 25 cm, 30.5 cm,



Standard
RI-5-402-11

Dressing Forceps
12 cm, 13 cm, 14.5 cm, 16 cm, 18 cm, 20 cm, 25 cm, 30 cm,



RI-5-403-13

Dressing Forceps
13 cm, 14.5 cm,



Stille

RI-5-404-15

Dressing Forceps
15 cm,



Mini-Adson

RI-5-405-12

Dressing Forceps
12 cm,



Adson

RI-5-406-12

Dressing Forceps
12 cm, 15 cm,

Dressing & Tissue Forceps



McIndoe
RI-5-407-15
Dressing Forceps
15 cm,



Waugh
RI-5-408-20
Dressing Forceps
20 cm,



Semken
RI-5-409-12
Dressing Forceps
12.5 cm, 15 cm,



Taylor
RI-5-410-17
Dressing Forceps
12.5 cm, 15 cm,



Taylor
RI-5-411-17
Dressing Forceps
17 cm,



Taylor
RI-5-412-17
Dressing Forceps
18.5 cm,

Dressing & Tissue Forceps



RI-5-413-06
Micro Dressing Forceps
15.5 cm,



Gerald
RI-5-414-18
Dressing Forceps
15.5 cm,



Cushing
RI-5-415-17
Dressing Forceps
17.5 cm,



Potts-Smith
RI-5-416-18
Dressing Forceps
18 cm, 21 cm, 24.5 cm,



Bonney
RI-5-417-17
Dissecting Forceps
17.5 cm,



Gerald
RI-5-418-17
Dissecting Forceps
17.5 cm,

Dressing & Tissue Forceps



Gillies
RI-5-419-15
Dissecting Forceps
15.5 cm,



McIndoe
RI-5-420-15
Dressing Forceps
15 cm,



Semken
RI-5-421-16
Dissecting Forceps
15.5 cm, 17.5 cm,



Adson-Brown
RI-5-422-12
Dissecting Forceps
12 cm,



Adson
RI-5-423-12
Dissecting Forceps
12 cm, 15 cm,



Adson
RI-5-424-12
Dressing Forceps
12 cm, 15 cm,

Dressing & Tissue Forceps



Cushing
RI-5-425-17
 Dressing Forceps
 17.5 cm,



Cushing
RI-5-426-18
 Dressing Forceps
 17 cm,



Cushing-Taylor
RI-5-427-18
 Dressing Forceps
 18.5 cm,



Potts-Smith
RI-5-428-15
 Dressing Forceps
 16 cm, 18.5 cm, 20 cm, 23 cm, 25 cm,



Oehler
RI-5-429-14
 Dissecting Forceps
 14.5 cm, 16 cm, 18 cm, 20 cm, 25 cm,



Wangensteen
RI-5-430-15
 Dressing Forceps
 15 cm, 23 cm,

Dressing & Tissue Forceps



DeBakey
RI-5-431-15

Atraumatic Dressing Forceps
16 cm, 20 cm, 24.5 cm, 16 cm, 20 cm, 24.5 cm,



DeBakey
RI-5-432-16

Atraumatic Dressing Forceps
16 cm, 20 cm, 24 cm,

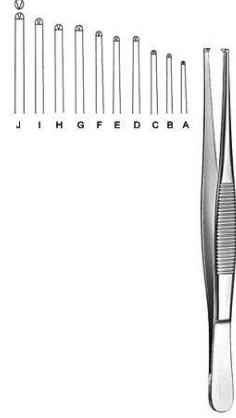

RI-5-433-10

Dissecting Forceps
10.5 cm, 11.5 cm, 13 cm, 14.5 cm, 16 cm, 18 cm, 20 cm, 23 cm, 25 cm, 30.5 cm,

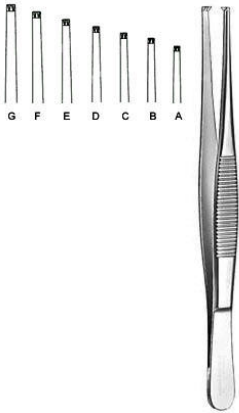

RI-5-434-11

Dissecting Forceps
12 cm, 13 cm, 14.5 cm, 15.5 cm, 18 cm, 20 cm, 24.5 cm,



RI-5-435-14

Dissecting Forceps
14.5 cm, 16 cm,



RI-5-436-14

Dissecting Forceps
14.5 cm, 16 cm,

Dressing & Tissue Forceps



RI-5-437-13
Dissecting Forceps
13 cm, 14.5 cm, 16 cm, 20 cm,



RI-5-438-13
Dissecting Forceps
13 cm, 14.5 cm,



Stille
RI-5-439-15
Dissecting Forceps
15 cm,



Stille
RI-5-440-15
Dissecting Forceps
15 cm,



Stone
RI-5-441-15
Dissecting Forceps
15 cm,



Lerche
RI-5-442-15
Dissecting Forceps
15 cm,

Dressing & Tissue Forceps

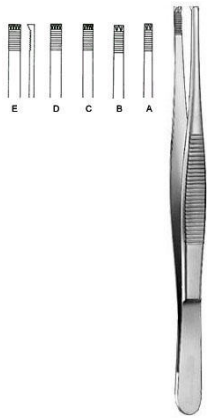

Adlerkreutz
RI-5-443-15

Dissecting Forceps
15.5 cm, 20.5 cm, 16 cm, 20 cm, 25 cm,

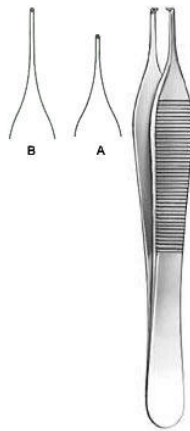

Adson

RI-5-444-12

Dissecting Forceps
12 cm, 15 cm,



Gillies

RI-5-445-15

Dissecting Forceps
15.5 cm,



Waugh

RI-5-446-20

Dissecting Forceps
20.5 cm,



Semken

RI-5-447-12

Dissecting Forceps
12.5 cm, 15 cm,



Taylor

RI-5-448-17

Dissecting Forceps
17.5 cm,

Dressing & Tissue Forceps



Taylor
RI-5-449-17
Dissecting Forceps
17 cm,



Taylor
RI-5-450-17
Dissecting Forceps
18.5 cm,



RI-5-451-06
Micro Dissecting Forceps
15.5 cm,



Gerald
RI-5-452-17
Dissecting Forceps
17.5 cm,



Cushing
RI-5-453-17
Dissecting Forceps
18 cm,



Potts-Smith
RI-5-454-18
Dissecting Forceps
18 cm, 21 cm, 24 cm,

Dressing & Tissue Forceps

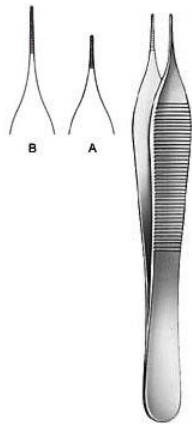

Mikro-Adson
RI-5-455-12
 Dressing Forceps
 12 cm, 15 cm,

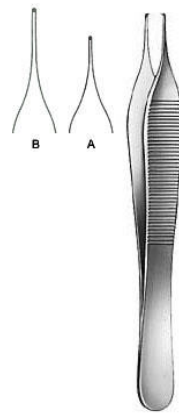

Mikro-Adson
RI-5-456-12
 Dissecting Forceps
 12 cm, 15 cm,



RI-5-457-11
 Dissecting Forceps
 10.5 cm,



Micro Jewelers
RI-5-458-12
 Jeweler Type Forceps
 12 cm Fig. 7,



Jewelers
RI-5-459-12
 Jeweler Type Forceps
 12 cm Fig. 3,



Jewelers
RI-5-460-11
 Jeweler Type Forceps
 11 cm Fig. 3c,

Dressing & Tissue Forceps



Jewelers
RI-5-461-11
Jeweler Type Forceps
11 cm Fig. 5,



Jewelers
RI-5-462-11
Jeweler Type Forceps
11 cm Fig. 4,



Stille-Barraya
RI-5-463-18
Dissecting Forceps
18 cm,



Bonney
RI-5-464-18
Dissecting Forceps
17.5 cm,



Nelson
RI-5-465-23
Dissecting Forceps
23 cm,



RI-5-466-10
Dressing Forceps
10 cm, 9.5 cm,

Dressing & Tissue Forceps



RI-5-467-12
Splinter Forceps smooth jaw
12.5 cm,



RI-5-468-12
Splinter Forceps smooth jaw
12.5 cm,



RI-5-469-12
Splinter Forceps
12.5 cm,



RI-5-470-12
Splinter Forceps
12.5 cm,



RI-5-471-16
Micro Tying Forceps
15.5 cm,



RI-5-472-10
Microscopic Forceps super light, blunt
10 cm,

Dressing & Tissue Forceps



RI-5-473-10
Microscopic Forceps
10 cm,



Shaaf
RI-5-474-09
Splinter Forceps
9.5 cm,



Littauer
RI-5-475-08
Cilia Forceps
8.5 cm,



RI-5-476-09
Cilia Forceps
8.5 cm,



Douglas
RI-5-477-09
Cilia Forceps
9 cm,



Douglas
RI-5-478-09
Cilia Forceps
9 cm,

Dressing & Tissue Forceps



Beer
RI-5-479-09
Cilia Forceps
9 cm,

Splinter Forceps



Phaneuf
RI-5-501-21
 Hysterectomy Forceps
 20.5 cm,



Wertheim-Cullen
RI-5-502-21
 Vaginal Clamp
 21 cm,

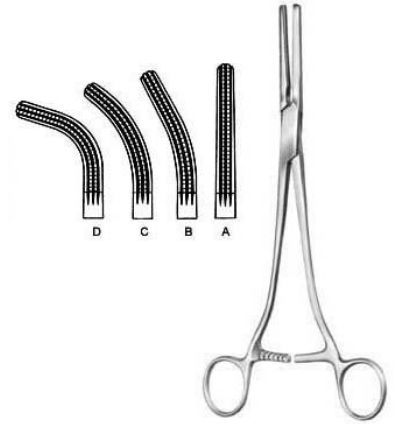

Rogers
RI-5-503-10
 Hysterectomy Forceps
 21.5 cm Fig. 1, 21 cm Fig. 2, 20.5 cm Fig. 3, 20 cm Fig. 4,



Moynihan
RI-5-504-23
 Hysterectomy Forceps
 23 cm,



Moynihan
RI-5-505-24
 Hysterectomy Forceps
 23.5 cm,



Wertheim
RI-5-506-25
 Hysterectomy Forceps
 26 cm,

Splinter Forceps

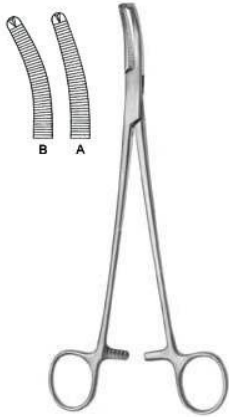

Wertheim
RI-5-507-22
Hysterectomy Forceps
22.5 cm,



Mikulicz, Baby
RI-5-508-14
Peritoneum Forceps
14.5 cm,



Mikulicz
RI-5-509-18
Peritoneum Forceps
20.5 cm,



Mikulicz
RI-5-510-20
Peritoneum Forceps
18.5 cm,



Mikulicz
RI-5-511-20
Peritoneum Forceps
20 cm,



Mikulicz
RI-5-512-21
Peritoneum Forceps
20.5 cm,

Splinter Forceps



Faure
RI-5-513-20
Peritoneum Forceps
21 cm,

Haemostatic Forceps



Pean
RI-5-601-14
Haemostatic Forceps
14.5 cm, 16 cm,

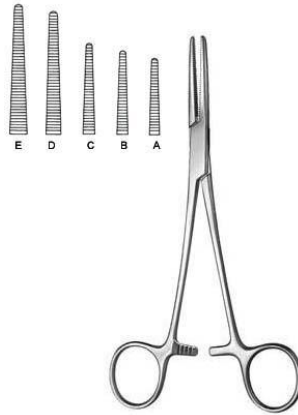

Spencer-Wells
RI-5-602-13
Haemostatic Forceps
13 cm, 14 cm, 15.5 cm, 18.5 cm, 20 cm,

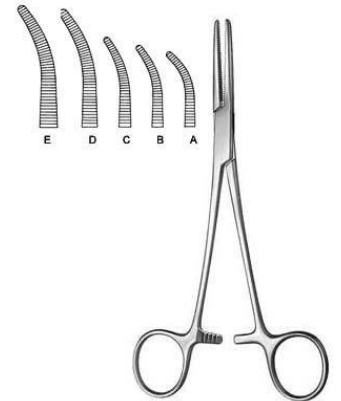

Spencer-Wells
RI-5-603-13
Haemostatic Forceps
13 cm, 14 cm, 15 cm, 18 cm, 20 cm,



Chaput
RI-5-604-13
Haemostatic Forceps
12.5 cm,



Tuffier
RI-5-605-13
Haemostatic Forceps
12.5 cm,

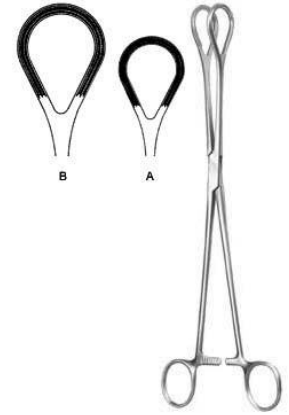

RI-5-606-25
Organ Grasping Forceps

Haemostatic Forceps



Collin
RI-5-607-14
Organ Grasping Forceps
15.5 cm, 21 cm,



Collin
RI-5-608-17
Tumor Grasping Forceps
17 cm,



Pennington
RI-5-609-15
Haemostatic Forceps
15.5 cm,



Pratt
RI-5-610-15
Haemostatic Forceps
15 cm,



Martel-Rees
RI-5-611-14
Face-lift Forceps
13.5 cm,



RI-5-612-12
Ligature Forceps

Haemostatic Forceps

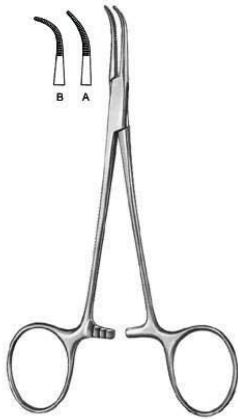

Mixer-Baby
RI-5-613-01

Dissecting and Ligature Forceps
13.5 cm, 13 cm,

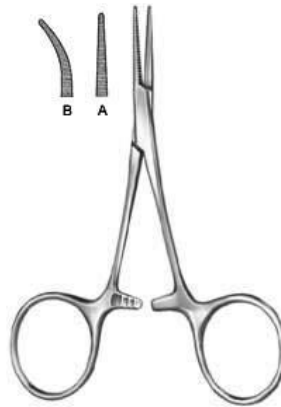

Hartmann
RI-5-614-10

Haemostatic Forceps
10 cm, 9.5 cm,



RI-5-615-12
Ligature Forceps

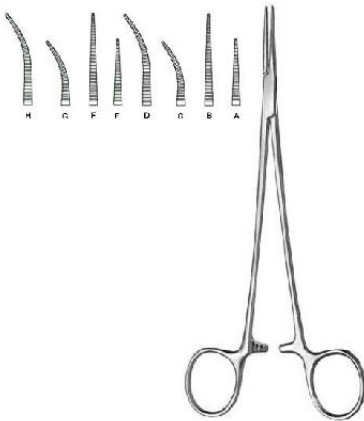

Halsted-Mosquito
RI-5-616-18

Haemostatic Forceps
12.5 cm, 14.5 cm, 14 cm,

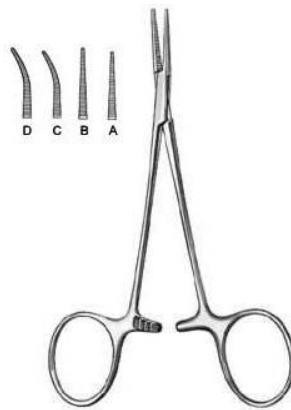

Mikro-Mosquito
RI-5-617-10

Haemostatic Forceps
10 cm, 12 cm, 9.5 cm, 11.5 cm,



Providence-Hospital
RI-5-618-14

Haemostatic Forceps
14 cm,

Haemostatic Forceps



Leriche
RI-5-619-15
Haemostatic Forceps
15.5 cm, 15 cm,

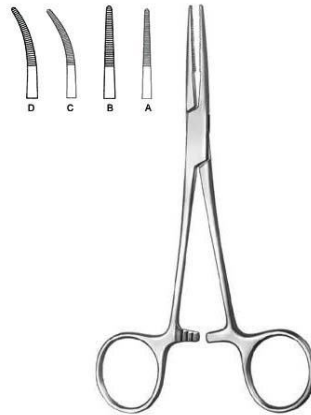

Kelly
RI-5-620-14
Haemostatic Forceps
14.5 cm, 14 cm,

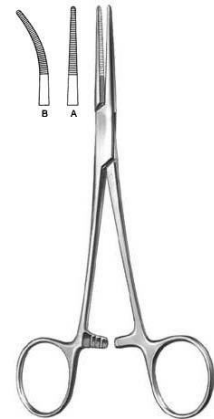

Kelly-Rankin
RI-5-621-16
Haemostatic Forceps
16 cm, 15.5 cm,



Overholt-Baby
RI-5-622-14
Dissecting and Ligature Forceps
14.5 cm, 14 cm,



Crile
RI-5-623-14
Haemostatic Forceps
14.5 cm, 14 cm,

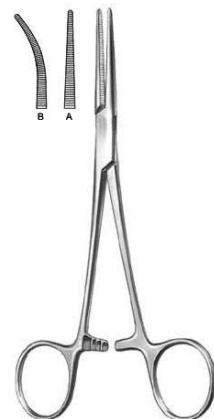

Crile-Rankin
RI-5-624-16
Haemostatic Forceps
16.5 cm, 16 cm,

Haemostatic Forceps

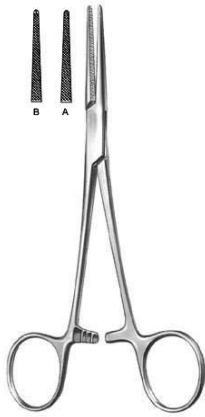

Lovlace
RI-5-625-15
Haemostatic Forceps
16 cm,



Dandy-Mosquito
RI-5-626-12
Haemostatic Forceps
12 cm,

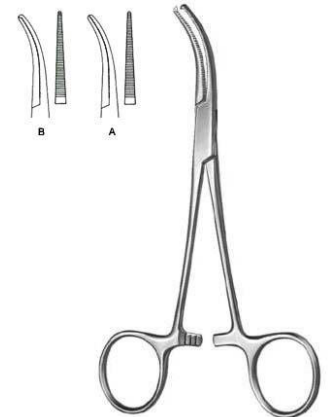

Dandy
RI-5-627-14
Haemostatic Forceps
14.5 cm, 14 cm,



Schnidt
RI-5-628-18
Dissecting and Ligature Forceps
18.5 cm, 19 cm,



Adson
RI-5-629-18
Dissecting and Ligature Forceps
19 cm, 18.5 cm,



Martin-Fuchsig
RI-5-630-20
Dissecting and Ligature Forceps
20.5 cm,

Haemostatic Forceps

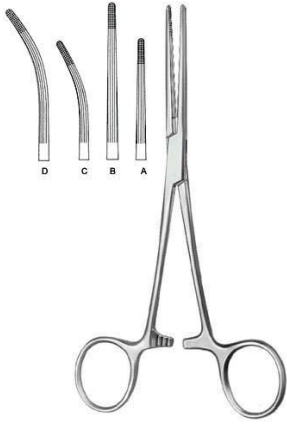

Rochester-Carmalt
RI-5-631-16

Haemostatic Forceps
17 cm, 20.5 cm, 16.5 cm, 20 cm,

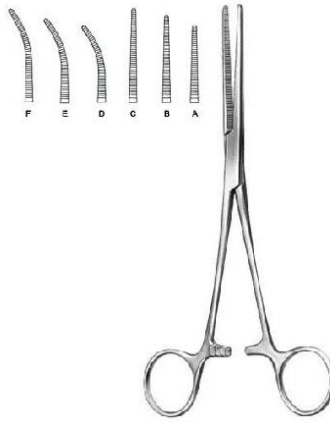

Pean

RI-5-632-13

Haemostatic Forceps
13.5 cm, 14.5 cm, 17 cm, 13 cm, 14 cm, 16.5 cm,



Kocher-Nippon

RI-5-633-14

Haemostatic Forceps
14.5 cm, 16.5 cm, 18.5 cm, 16 cm, 18 cm,

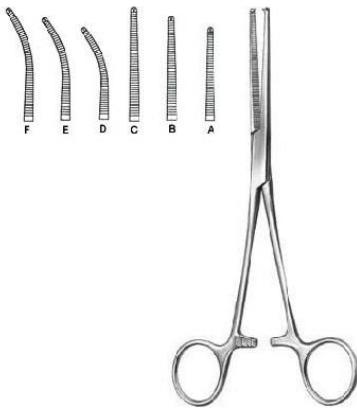

Kocher

RI-5-635-13

Haemostatic Forceps
13 cm, 14 cm, 16 cm,

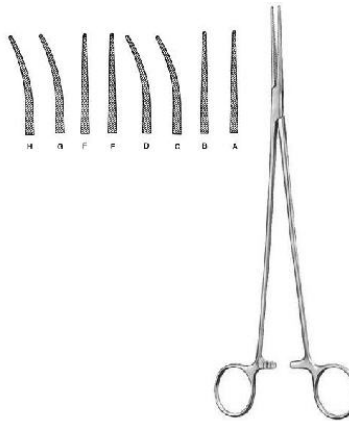

Bengolea

RI-5-636-20

Haemostatic Forceps
21.5 cm, 26 cm, 21 cm, 21.5 cm,

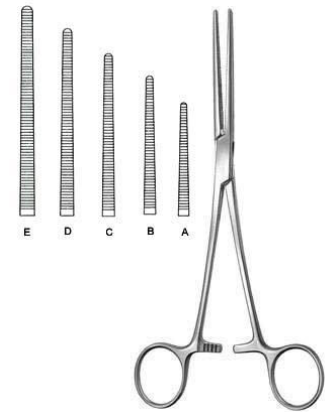

Pean (Rochester)

RI-5-637-14

Haemostatic Forceps
14.5 cm, 16.5 cm, 18.5 cm, 20.5 cm, 22.5 cm, 24.5 cm, 26 cm, 30.5 cm, 14 cm, 16 cm,

Haemostatic Forceps



Overholt-Mixer
RI-5-644-21

Dissecting and Ligature Forceps
21.5 cm,

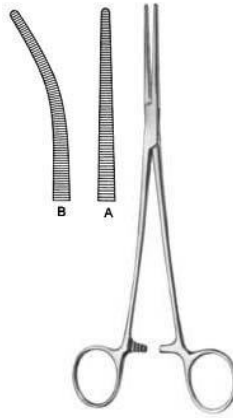

Roberts
RI-5-645-22

Dissecting and Ligature Forceps
22.5 cm, 21.5 cm,

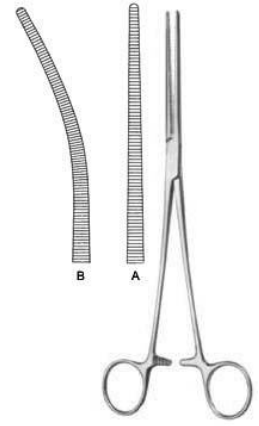

Sarot
RI-5-646-24

Dissecting and Ligature Forceps
25 cm, 24.5 cm,

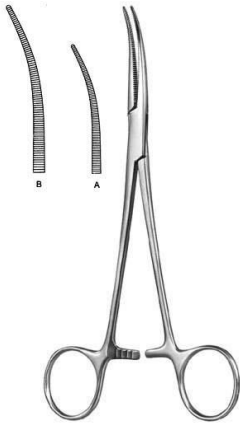

Crafoord
RI-5-647-18

Dissecting and Ligature Forceps
18 cm, 24.5 cm,

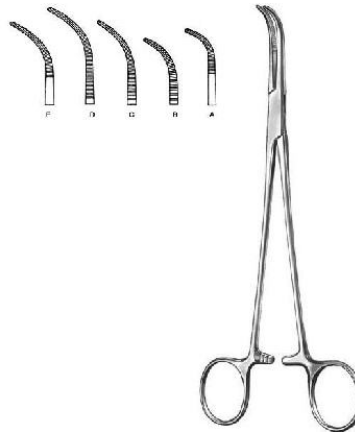

Overholt-Geissendorfer
RI-5-648-01

Dissecting and Ligature Forceps
20.5 cm Fig. 1, 20 cm Fig. 2, 21.5 cm Fig. 3, 22 cm Fig. 4, 21.5 cm Fig. 5, 22 cm Fig. 6, 27 cm Fig. 1, 26.5 cm Fig. 2, 27.5 cm Fig. 3, 28 cm Fig. 4,

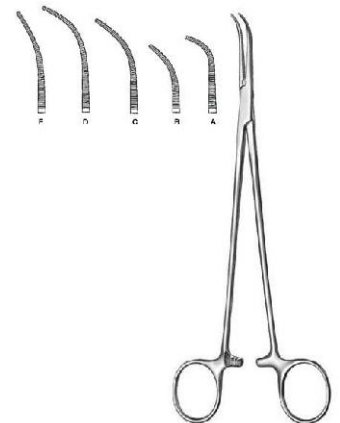

Overholt-Fino
RI-5-649-00

Dissecting and Ligature Forceps
21.5 cm, 21 cm, 22 cm, 23 cm, 22.5 cm,

Haemostatic Forceps

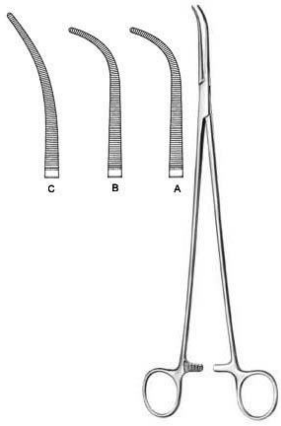

Overholt
RI-5-650-00

Dissecting and Ligature Forceps
29.5 cm, 30 cm,



Overholt-Mini
RI-5-651-01

Dissecting and Ligature Forceps
15 cm, 20 cm,

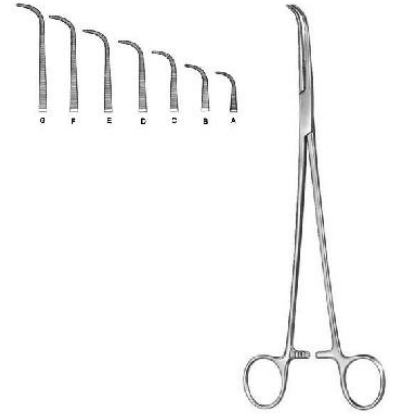

Gemini
RI-5-652-13

Dissecting and Ligature Forceps
13 cm, 16 cm, 18 cm, 21 cm, 23 cm, 25 cm, 28 cm,

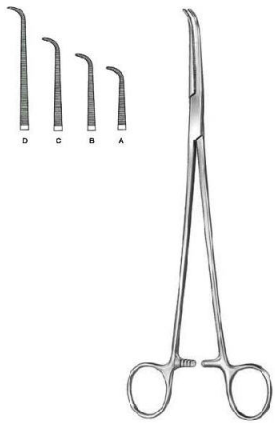

Mini-Gemini
RI-5-653-18

Dissecting and Ligature Forceps
18 cm, 22.5 cm, 25 cm, 28.5 cm,

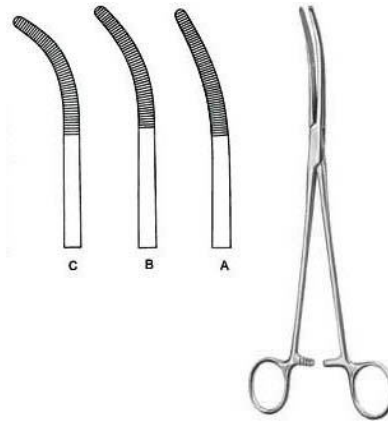

Rumel
RI-5-654-01

Dissecting and Ligature Forceps
24 cm Fig. 1, 23.5 cm Fig. 2, 23 cm Fig. 3, 24 cm Fig. 4, 23.5 cm Fig. 5,

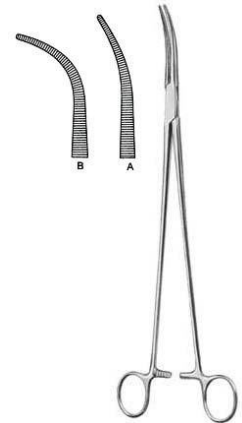

Zenker
RI-5-655-01

Dissecting and Ligature Forceps
29.5 cm, 28.5 cm,

Haemostatic Forceps



Mixer-Baby
RI-5-656-14

Dissecting and Ligature Forceps
13.5 cm,

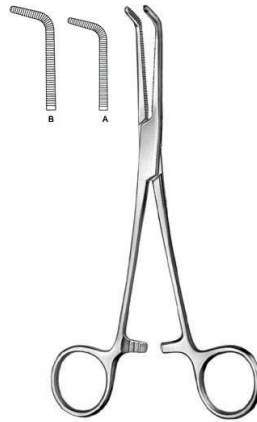

Mixer
RI-5-657-15

Dissecting and Ligature Forceps
16 cm, 18 cm,



Mixer-O Shaugnessy
RI-5-658-19

Dissecting and Ligature Forceps
18 cm,



Mixer
RI-5-659-22

Dissecting and Ligature Forceps
22.5 cm,



Mixer
RI-5-660-23

Dissecting and Ligature Forceps
23 cm,

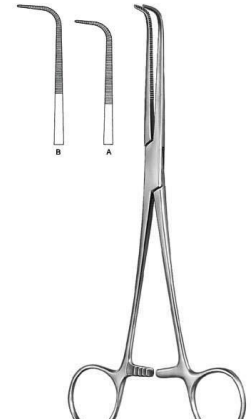

Wickstrom
RI-5-661-21

Dissecting and Ligature Forceps
21 cm, 24.5 cm,

Haemostatic Forceps

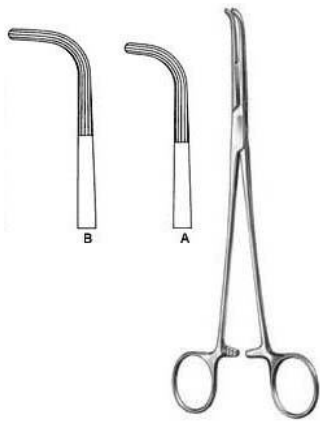

Mixer

RI-5-662-22

Dissecting and Ligature Forceps
22.5 cm, 26 cm, 28 cm,



Mc Quigg-Mixer

RI-5-663-22

Dissecting and Ligature Forceps
23.5 cm,



Lower

RI-5-664-18

Dissecting and Ligature Forceps
18.5 cm,

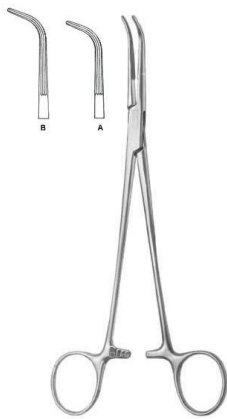

Lahey

RI-5-665-19

Bile Duct Clamp
19.5 cm, 22.5 cm,



Finochietto

RI-5-666-24

Dissecting and Ligature Forceps
24 cm,



Uro-Tangential

RI-5-667-01

Tangential Forceps
25 cm, 27 cm,

Haemostatic Forceps

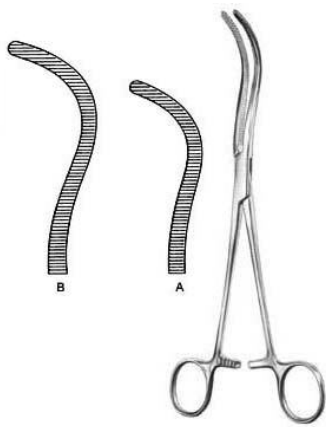

Guyon

RI-5-668-20

Kidney Pedicle Clamp
23 cm, 24 cm,



Guyon

RI-5-669-23

Kidney Pedicle Clamp
19.5 cm, 21.5 cm, 24 cm,



Desjardins

RI-5-670-21

Bile Duct Clamp
21 cm,

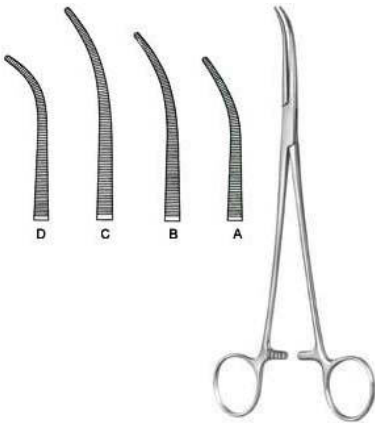

Kelly

RI-5-671-19

Dissecting and Ligature Forceps
19.5 cm Fig. 1, 22.5 cm Fig. 1, 24.5 cm Fig.
1, 19 cm Fig. 2, 22 cm Fig. 2, 24 cm Fig.
2, 18.5 cm Fig. 3, 21.5 cm Fig. 3, 23.5 cm Fig.
3,



Lawrence

RI-5-672-28

Dissecting and Ligature Forceps
28 cm,



Meeker

RI-5-673-28

Dissecting and Ligature Forceps
28 cm,

Haemostatic Forceps



Negus

RI-5-674-19

Haemostatic Forceps
19.5 cm Fig. 1, 20 cm Fig. 2,

Towel & Tubing Clamps



Schaedel
RI-5-701-09
Towel Clamp sharp
9 cm,



Jones
RI-5-702-05
Towel Clamp sharp
5.5 cm, 8.5 cm,



Jones-Martin
RI-5-703-09
Towel Clamp sharp
8.5 cm,



Backhaus
RI-5-704-11
Towel Clamp
11.5 cm, 13 cm,



Backhaus
RI-5-705-11
Towel Clamp
11.5 cm,



Backhaus
RI-5-706-08
Towel Clamp
9 cm, 11.5 cm, 13 cm, 16 cm,

Towel & Tubing Clamps

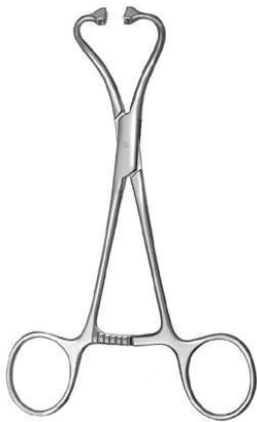

Peers-Bertram modif.
RI-5-707-15

Towel Clamp wide jaw for tube fixation
15.5 cm,



R?der
RI-5-708-13

Towel Clamp
13.5 cm,

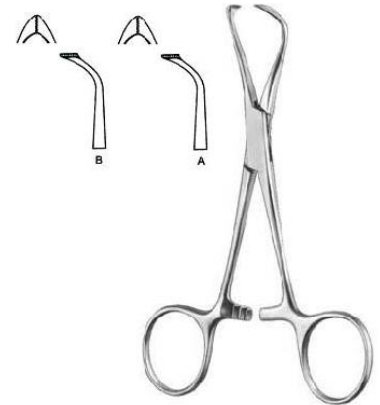

Lorna
RI-5-709-10

Towel Clamp fine serrated, wide jaw
9.5 cm, 13 cm,



Bernhard
RI-5-710-16

Towel Clamp
16.5 cm,

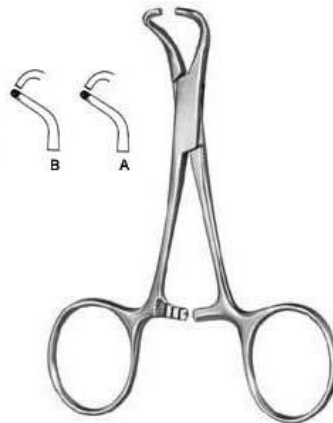

Tohoku
RI-5-711-10

Towel Clamp
10.5 cm blunt, 13.5 cm blunt, 14.5 cm,

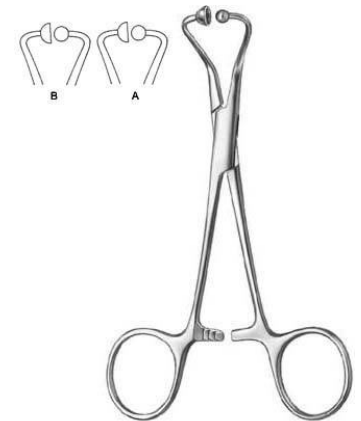

RI-5-712-11

Towel Clamp for paper clothes
11.5 cm, 14 cm,

Towel & Tubing Clamps



Lane
RI-5-713-20
Towel Clamp
19.5 cm,



RI-5-714-06
Tube Holder for fixation of six tubes



RI-5-715-14
Tubing Clamp extra long ratchet
14 cm,



RI-5-716-16
Tubing Clamp
16.5 cm,

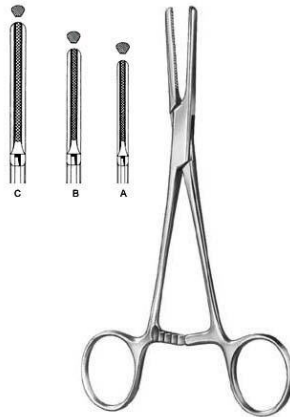

RI-5-717-15
Tubing Clamp
15.5 cm, 19 cm, 20.5 cm,

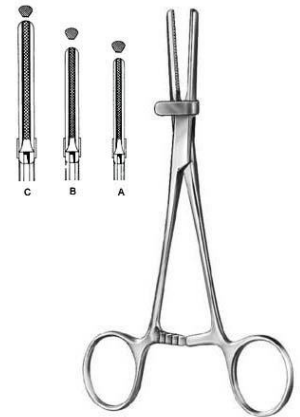

RI-5-718-15
Tubing Clamp with safety guard
15.5 cm, 19 cm, 20.5 cm,

Towel & Tubing Clamps



Lane
RI-5-713-20
 Towel Clamp
 19.5 cm,



RI-5-714-06
 Tube Holder for fixation of six tubes



RI-5-715-14
 Tubing Clamp extra long ratchet
 14 cm,



RI-5-716-16
 Tubing Clamp
 16.5 cm,

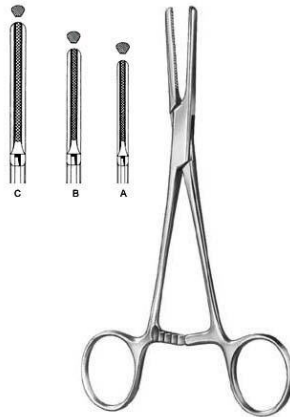

RI-5-717-15
 Tubing Clamp
 15.5 cm, 19 cm, 20.5 cm,

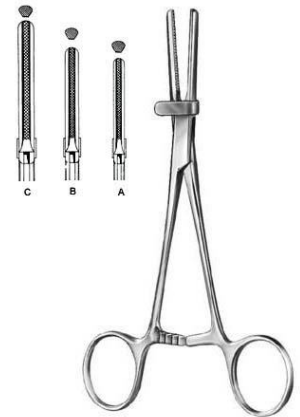

RI-5-718-15
 Tubing Clamp with safety guard
 15.5 cm, 19 cm, 20.5 cm,

Dressing & Sponge Forceps

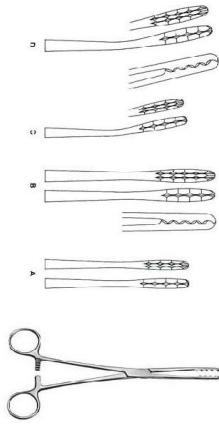

Ulrich

RI-5-801-22

Dressing Forceps
22.5 cm, 26.5 cm,

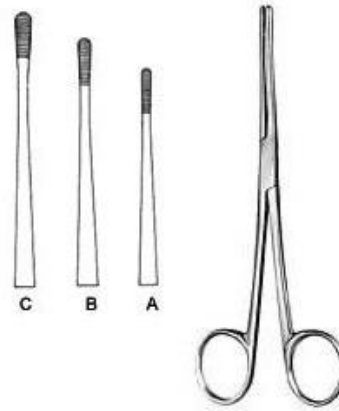

Lister

RI-5-802-13

Sinus Forceps
13 cm, 16 cm, 18 cm,



Martin

RI-5-803-17

Dressing Forceps
17.5 cm, 17 cm,

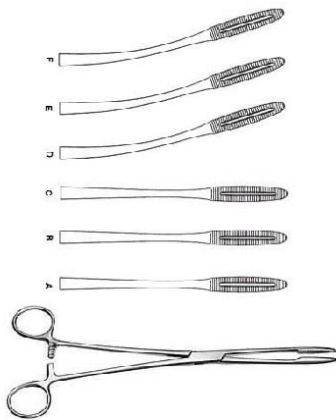

Gross-Maier

RI-5-804-20

Dressing Forceps
20.5 cm, 22 cm, 26.5 cm, 20 cm, 21.5 cm, 26 cm,



RI-5-805-40

Tunneling Forceps
39.5 cm,



Collin

RI-5-806-25

Dressing Forceps
25.5 cm,

Dressing & Sponge Forceps



Cheron
RI-5-807-25
Dressing Forceps
23.5 cm,



Bozemann
RI-5-808-26
Sponge Forceps
26 cm,

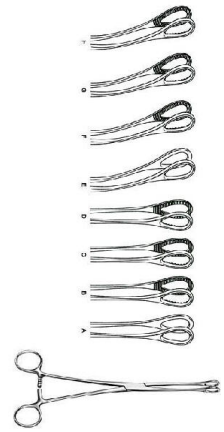

Foerster
RI-5-809-25
Sponge Forceps
25 cm, 18 cm, 20.5 cm, 24.5 cm, 17.5 cm, 20 cm, 24.5 cm,

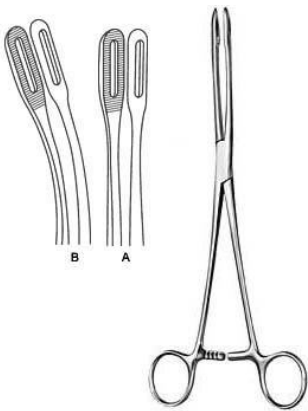

Foerster
RI-5-810-25
Sponge Forceps
25 cm, 24.5 cm,

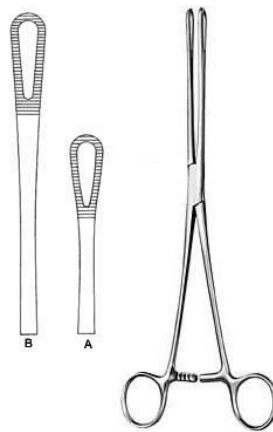

Rampley
RI-5-811-18
Sponge Forceps
18.5 cm, 24.5 cm,

Retractors



Vickers
RI-5-901-18
Skin Hooklet
18.5 cm,



Vickers
RI-5-902-01
Bone Hooklet
17 cm,



Vickers
RI-5-903-01
Tendon Hooklet
17 cm,



Vickers
RI-5-904-02
Hooklet
16 cm,

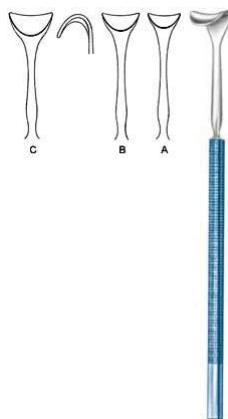

Vickers
RI-5-905-12
Saddle Hook
14 cm,



Graefe
RI-5-906-01
Micro Hooklet
15 cm,

Retractors

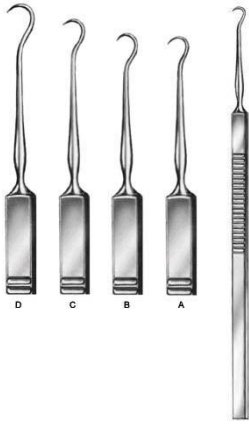

RI-5-907-01

Skin Hook

16 cm Fig. 1, 16 cm Fig. 2, 16 cm Fig. 3, 16 cm Fig. 4,



O Connor

RI-5-908-16

Skin Hook

16 cm,

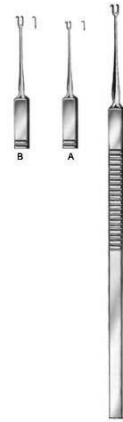

Guthrie

RI-5-909-01

Skin Hook

15.5 cm,

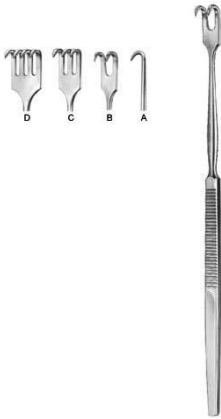

RI-5-910-01

Hooklet

16.5 cm,



RI-5-911-01

Hooklet

16.5 cm,



RI-5-912-02

Hooklet

16 cm,

Retractors



RI-5-919-01
Hooklet
16.5 cm,



RI-5-920-01
Hooklet
16.5 cm,



Meyerding
RI-5-921-01
Hooklet
17.5 cm Fig. 1, 17.5 cm Fig. 2, 17.5 cm Fig. 3, 17.5 cm Fig. 4, 17.5 cm Fig. 5, 17.5 cm Fig. 6,



Senn-Green
RI-5-922-01
Hooklet
15 cm Fig. 1, 15 cm Fig. 2,



Ragnell-Davis
RI-5-923-14
Hooklet
14 cm,

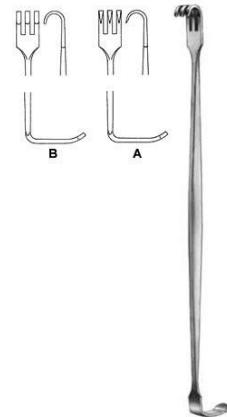

Senn-Miller
RI-5-924-16
Hooklet
16 cm,

Retractors



Cushing
RI-5-925-20
Retractor
20.5 cm,



Cushing
RI-5-926-08
Saddle Hook
20.5 cm 8 mm wide, 20.5 cm 10 mm wide, 20.5 cm 12 mm wide, 20.5 cm 14 mm wide, 20.5 cm 16 mm wide, 20.5 cm 18 mm wide,



Cushing
RI-5-927-08
Saddle Hook 8 mm to 18 mm wide
24 cm,



Brom
RI-5-928-01
Vein Hook
19.5 cm,



Strandell-Stille
RI-5-929-01
Hooklet
19 cm Fig. 1, 19 cm Fig. 2,



Klapp
RI-5-930-01
Retractor 12 x 6, 12 x 11, 15 x 11
17.5 cm,

Retractors



RI-5-931-04
Hooklet
16.5 cm,

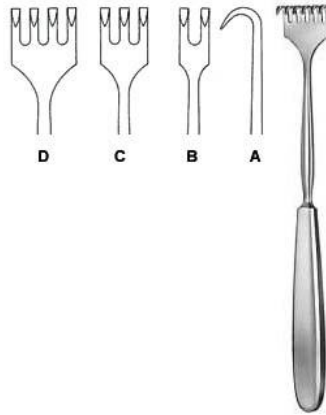

Volkman
RI-5-932-01
Retractor
21.5 cm,

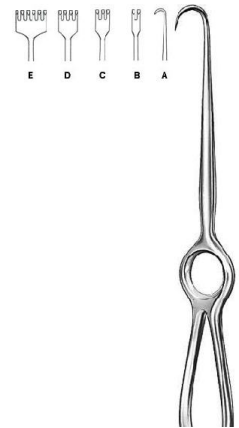

Volkman
RI-5-933-01
Retractor
22 cm, 21.5 cm,

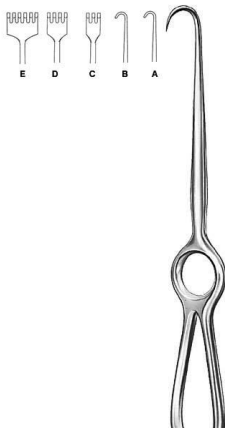

Kocher
RI-5-934-01
Retractor
22 cm,

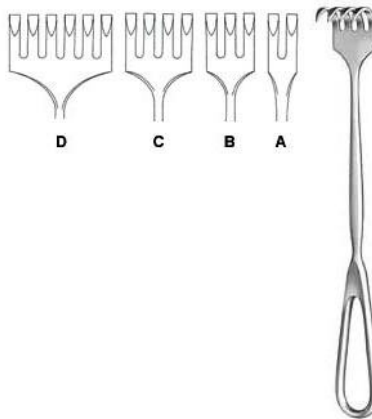

Martin
RI-5-935-02
Retractor
22.5 cm,

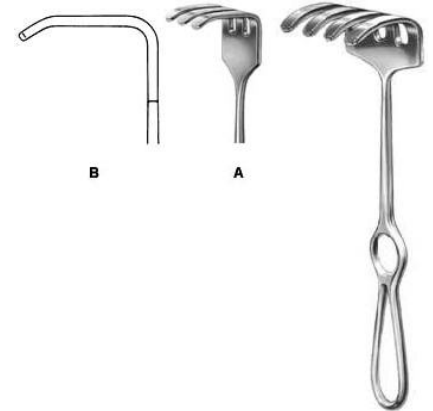

Ollier
RI-5-936-03
Retractor
23 cm 36 x 30, 23 cm 36 x 60,

Retractors

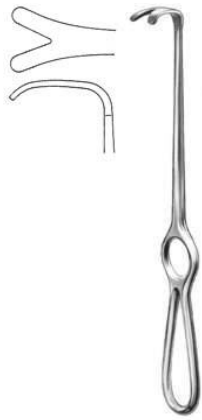

Wassmund
RI-5-937-02
 Retractor
 20.5 cm 33 x 21,

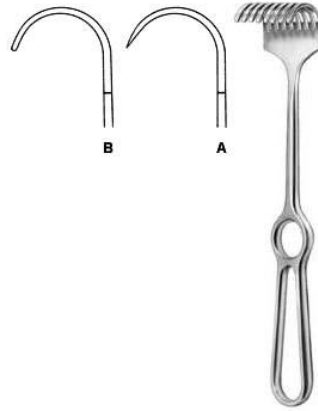

Korte
RI-5-938-08
 Retractor
 24.5 cm 40 x 30,

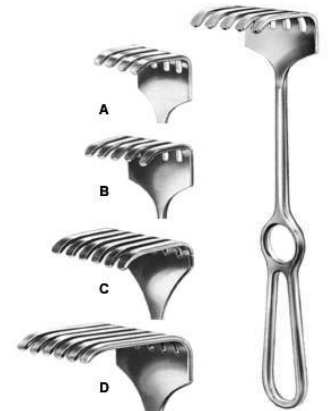

Israel
RI-5-939-04
 Retractor
 25.5 cm,

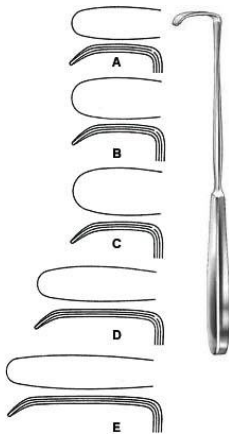

Langenbeck
RI-5-940-01
 Retractor
 22.5 cm 30 x 11 mm, 22.5 cm 30 x 14 mm, 22.5 cm 30 x 16 mm, 22.5 cm 40 x 11 mm, 22.5 cm 50 x 11 mm,

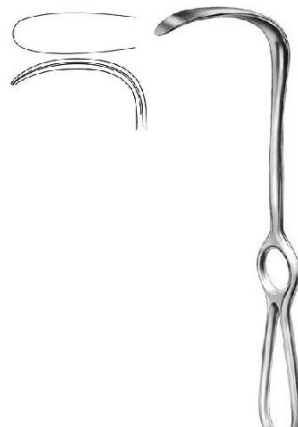

Langenbeck
RI-5-942-21
 Retractor
 21 cm 65 x 20 mm,



Langenbeck
RI-5-943-21
 Retractor
 22.5 cm 85 x 15 mm,

Retractors



Lahey
RI-5-944-19
Retractor
19.5 cm 36 x 19 mm,



Little
RI-5-945-20
Retractor
20 cm 13 x 15 mm,

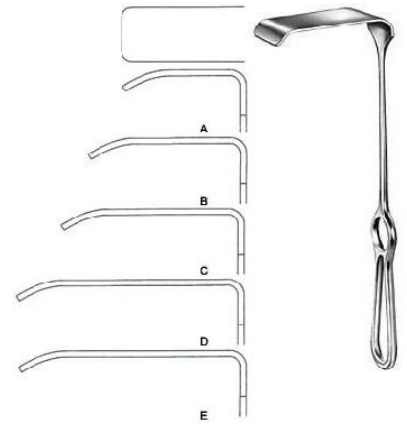

Kocher
RI-5-946-18
Retractor
23 cm 43 x 18 mm, 23 cm 53 x 20 mm, 23 cm 63 x 25 mm, 23 cm 77 x 30 mm, 23 cm 78 x 40 mm,

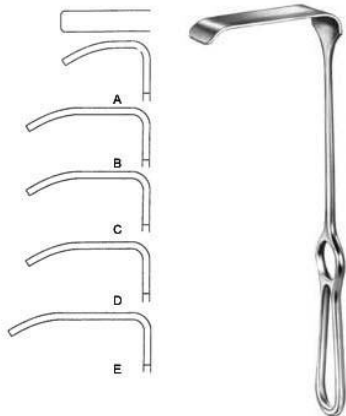

Kocher-Langenbeck
RI-5-947-01
Retractor
21.5 cm 25 x 6 mm, 21.5 cm 35 x 8 mm, 21.5 cm 35 x 11 mm, 21.5 cm 35 x 15 mm, 21.5 cm 40 x 11 mm, 21.5 cm 55 x 11 mm, 21.5 cm 70 x 14 mm, 21.5 cm 80 x 12 mm,

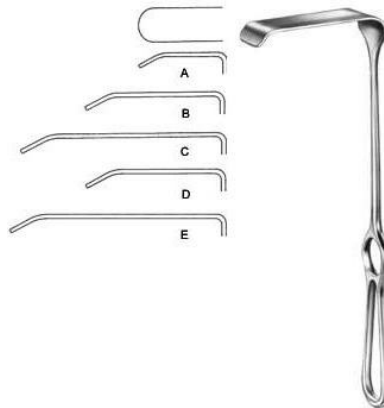

Kocher-Langenbeck
RI-5-948-01
Retractor
21.5 cm 25 x 10 mm, 21.5 cm 40 x 13 mm, 21.5 cm 60 x 13 mm, 21.5 cm 40 x 18 mm, 21.5 cm 60 x 18 mm, 21.5 cm 85 x 18 mm, 21.5 cm 60 x 25 mm, 21.5 cm 85 x 25 mm,

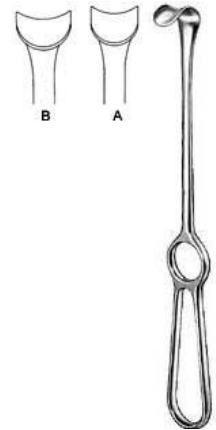

Kocher
RI-5-949-01
Retractor
21.5 cm 22 x 12 mm, 21.5 cm 24 x 14 mm,

Retractors

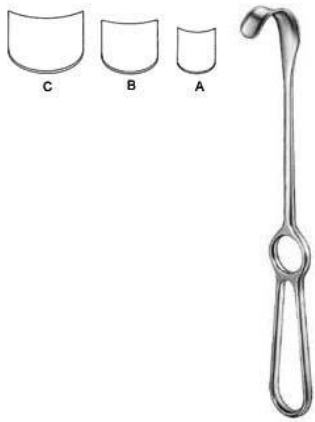

Kocher
RI-5-950-01

Retractor
22 cm 42 x 10 mm, 22 cm 42 x 15 mm, 22 cm
43 x 20 mm,

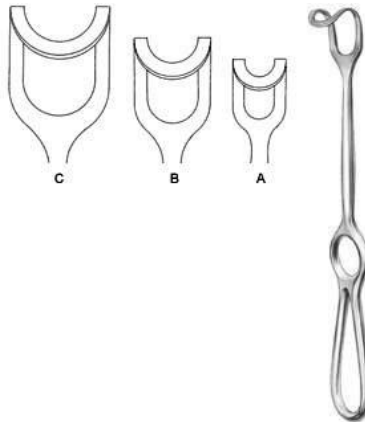

Middeldorpf
RI-5-951-01

Retractor
21.5 cm 18 x 17 mm, 23 cm 25 x 22 mm, 24.5
cm 30 x 31 mm,



Doyen-Stillé
RI-5-952-01

Retractor
26 cm 97 x 29 mm, 26 cm 101 x 31 mm, 26
cm 127 x 52 mm,

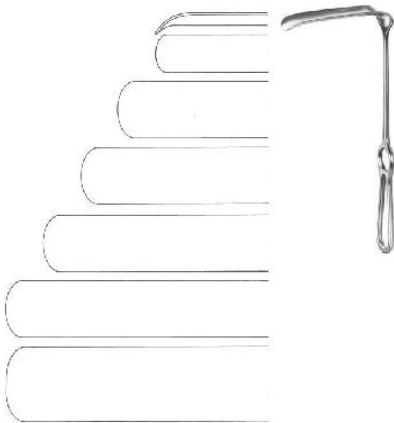

Hosel
RI-5-953-01

Retractor
26 cm 63 x 21 mm, 26 cm 83 x 30 mm, 26 cm
103 x 30 mm, 26 cm 120 x 30 mm, 26 cm 140
x 30 mm, 26 cm 140 x 40 mm,

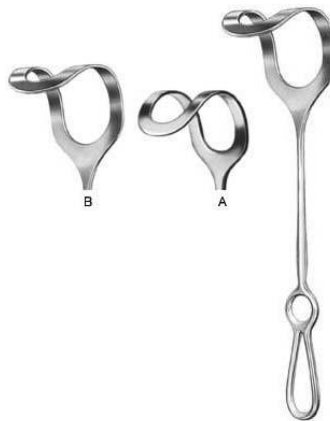

Middeldorpf
RI-5-954-01

Retractor
27 cm 48 x 45 mm, 27 cm 52 x 50 mm, 27 cm
60 x 70 mm,

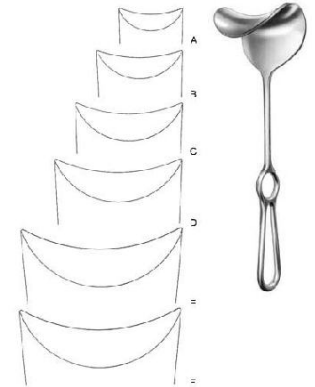

Fritsch
RI-5-955-00

Retractor
23.5 cm 37 x 31 mm, 24 cm 38 x 40 mm, 25
cm 43 x 51 mm, 25 cm 49 x 61 mm, 25.5 cm
48 x 75 mm, 25.5 cm 65 x 85 mm,

Retractors



Doyen
RI-5-956-25
 Retractor
 24 cm 48 x 88 mm,



Kocher
RI-5-957-22
 Retractor
 24 cm 73 x 25 mm,



Kocher
RI-5-958-01
 Retractor
 25 cm 80 x 45 mm, 25 cm 80 x 55 mm, 25 cm
 80 x 65 mm,



Martin
RI-5-959-25
 Retractor
 26 cm 110 x 27 mm,

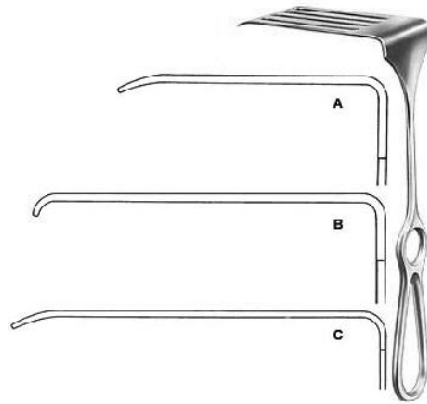

Coryllos
RI-5-960-01
 Retractor
 24 cm 85 x 22 mm, 24 cm 108 x 43 mm, 24
 cm 119 x 65 mm,



Davidson
RI-5-961-01
 Retractor
 19 cm 80 x 54 mm, 18.5 cm 80 x 95 mm,

Retractors

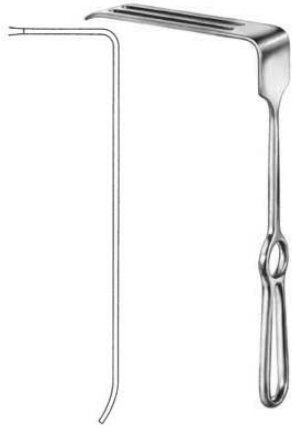

Sauerbruch
RI-5-962-25
Retractor
25.5 cm 127 x 38 mm,

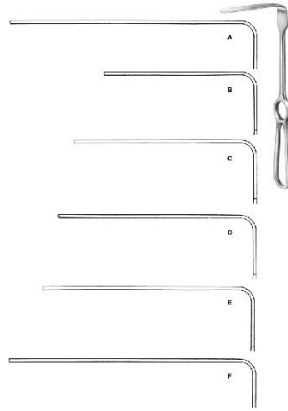

Brunner
RI-5-963-08
Retractor
25.5 cm 84 x 20 mm, 25.5 cm 104 x 25 mm, 25.5 cm 124 x 30 mm, 25.5 cm 130 x 30 mm, 25.5 cm 144 x 30 mm, 25.5 cm 160 x 30 mm, 25.5 cm 164 x 30 mm,

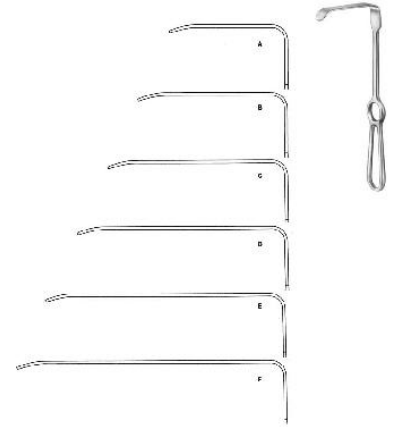

Brunner
RI-5-964-08
Retractor
25.5 cm 82 x 20 mm, 25.5 cm 102 x 20 mm, 25.5 cm 122 x 25 mm, 25.5 cm 140 x 25 mm, 25.5 cm 162 x 30 mm, 25.5 cm 182 x 30 mm,

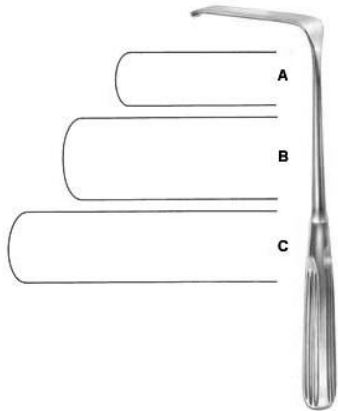

Sauerbruch
RI-5-965-01
Retractor
22.5 cm 50 x 15mm, 22.5 cm 63 x 23mm, 22.5 cm 80 x 20mm,



Deaver
RI-5-966-01
Retractor
18 cm 19mm,

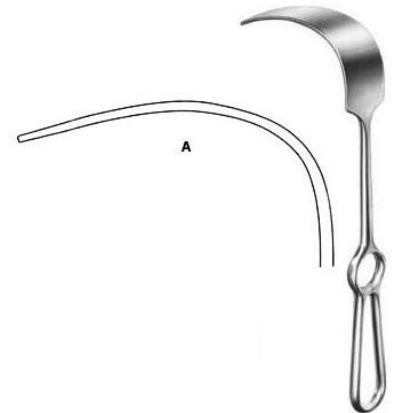

Mikulicz
RI-5-968-01
Retractor
25 cm 90 x 35mm, 25 cm 125 x 50mm, 25 cm 160 x 50mm,

Retractors



Mikulicz
RI-5-969-26
Retractor
26 cm 90 x 55mm,

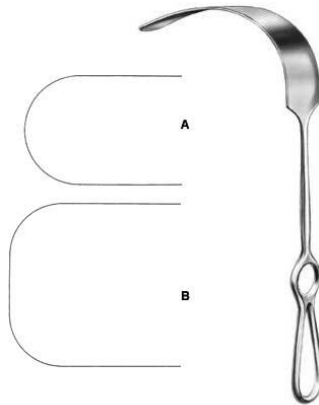

Kelly
RI-5-970-01
Retractor
27.5 cm 205 x 38mm, 27.5 cm 205 x 57mm,



Farabeuf
RI-5-971-00
Retractor
15 cm Fig. 1 = 23 x 16, 15 cm Fig. 1 = 26 x 16, 15 cm Fig. 2 = 27 x 16, 15 cm Fig. 2 = 30 x 16,

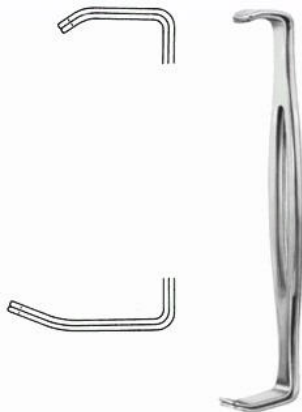

Parker-Langenbeck
RI-5-972-00
Retractor
21.5 cm Fig. 1 = 21x15mm, 21.5 cm Fig. 1 = 40x15mm, 21.5 cm Fig. 2 = 25x15mm, 21.5 cm Fig. 2 = 45x15mm,



Alm
RI-5-973-07
Wound Spreaders, self-retaining
7 cm,



Alm
RI-5-974-07
Wound Spreaders, self-retaining
7 cm,

Retractors



Gosset
RI-5-975-22
Abdominal Retractor
18.5 cm,



Balfour-Baby
RI-5-976-00
Abdominal Retractor spreading 90mm, 1
central blade 24 x 20mm
12.5 cm,



Balfour
RI-5-977-00
Abdominal Retractor spreading 180mm,
lateral blades 70 x 35mm, 1 central blade
20 cm,



Deaver
RI-5-967-04
Retractor
31.5 cm 25mm, 31.5 cm 38mm, 31.5 cm
50mm, 31.5 cm 100mm,

Probes



RI-5-1001-11

Probe

11.5 cm, 13 cm, 14.5 cm, 16 cm, 18 cm, 20 cm, 25 cm, 30 cm,



RI-5-1002-11

Probe

11.5 cm, 13 cm, 14.5 cm, 16 cm, 18 cm, 20 cm, 25 cm, 30 cm,

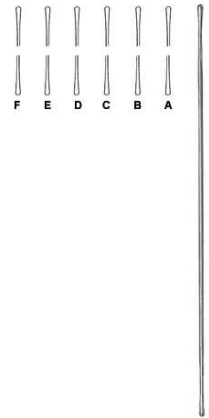

RI-5-1003-13

Probe

13 cm, 14.5 cm, 16 cm, 18 cm, 20 cm, 25 cm,



RI-5-1004-13

Probe with eye

13 cm, 14.5 cm, 16 cm,

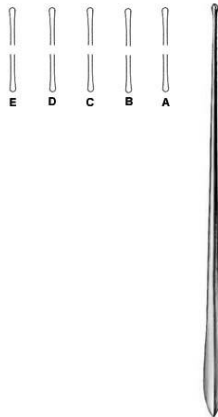

RI-5-1006-13

Myrtle Leaf Probe

13 cm, 14.5 cm, 16 cm, 18 cm, 20 cm,



RI-5-1007-13

Grooved Director

13 cm, 14 cm, 16 cm,

Probes



RI-5-1008-13
Grooved Director
13 cm, 14.5 cm, 16 cm,



Doyen
RI-5-1009-14
Grooved Director
14.5 cm,



Nelaton
RI-5-1010-16
Grooved Director
16 cm,

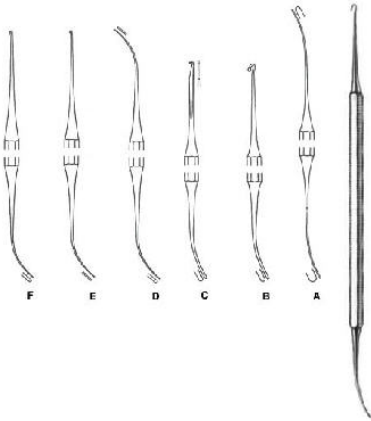

Varady
RI-5-1011-01
Phlebodissector
18 cm, 17.5 cm,

Plaster

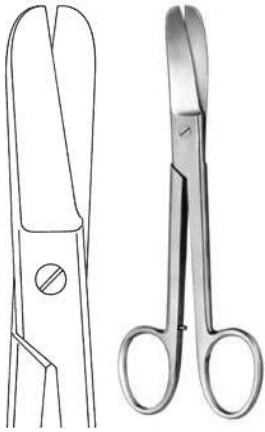

Lorenz

RI-6-101-23

Bandage Scissors heavy pattern
23 cm,



Lister

RI-6-102-14

Bandage Scissors
14.5 cm, 18.5 cm, 20 cm,



Bergmann

RI-6-103-23

Plaster Shears
23.5 cm,



Esmarch

RI-6-104-20

Plaster Shears heavy pattern, short blades
20 cm,



RI-6-105-15

Bandage Scissors black plastic ring with
autodavable
16 cm, 19 cm,



RI-6-106-18

Bandage Scissors black plastic rings
19 cm, 16 cm,

Plaster

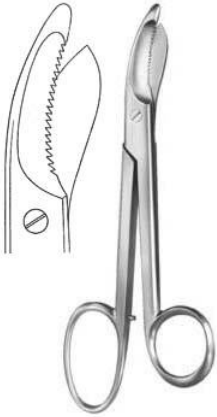

Brun's
RI-6-107-24
Plaster Scissors
24 cm,

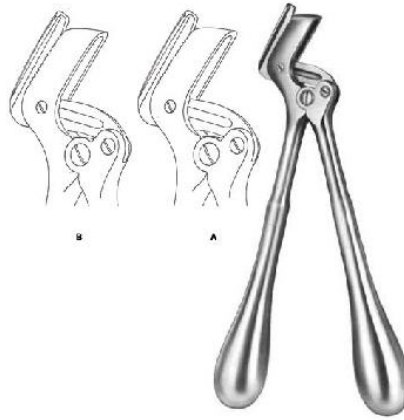

Stille-Martin
RI-6-108-23
Plaster Shears
23 cm, 27 cm, 38 cm,

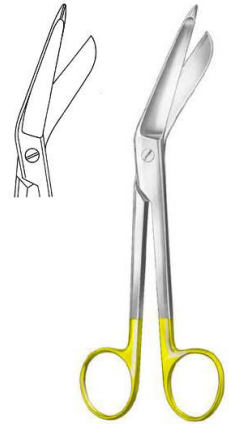

Lister
RI-6-109-18
Bandage Scissors
18 cm,



Brun's
RI-6-110-24
Plaster Scissors
24 cm,



Hopkins
RI-6-111-20
Plaster Knife with wooden handle
20 cm,



Reiner
RI-6-112-18
Plaster Knife
18 cm,

Plaster



Reiner
RI-6-113-18
Plaster Knife
18 cm,



Martin
RI-6-114-21
Plaster Knife with wooden handle
21 cm,



Engel
RI-6-115-14
Plaster Saw
15.5 cm,



Hennig
RI-6-116-28
Plaster Spreader
28 cm,

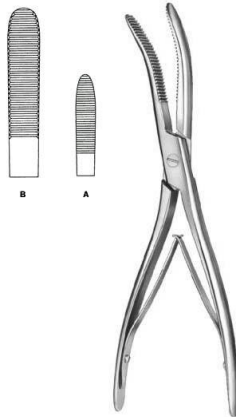

Wolf
RI-6-117-18
Plaster Breaker
18 cm, 26.5 cm,

Neurosurgery



Gigli
RI-8-101-01
Wire Saw Handle



De Martel
RI-8-102-33
Wire Saw Guide
33 cm,



Crutchfield
RI-8-103-01
Skull Traction Tong small pattern



RI-8-104-01
Skull Traction Tong large pattern
22.5 cm,



Dahlgren
RI-8-105-20
Cranial Rongeur
20 cm,



Olivecrona-Toennis
RI-8-106-14
Clip Applying Forceps

Neurosurgery



McKenzie
RI-8-107-19
Clip Applying Forceps
18.5 cm,



Olivecrona
RI-8-108-18
Dura Dissector
18 cm,



Olivecrona
RI-8-109-19
Dura Dissector
20 cm,



Milligan
RI-8-110-21
Dura Dissector
21.5 cm,



Davis
RI-8-111-21
Dura Dissector sharp
21.5 cm,



RI-8-112-22
Dura Dissector
22 cm,

Neurosurgery



Davis
RI-8-113-24
Dura Dissector
24.5 cm,



Love
RI-8-114-19
Nerve Root Retractor
21.5 cm, 18 cm, 11 cm,



Olivecrona
RI-8-115-18
Brain Spatula
18 cm,



Scoville
RI-8-116-23
Nerve Root Retractor 8mm
23.5 cm,



Holsher
RI-8-117-24
Nerve Root Retractor 8mm
23.5 cm,

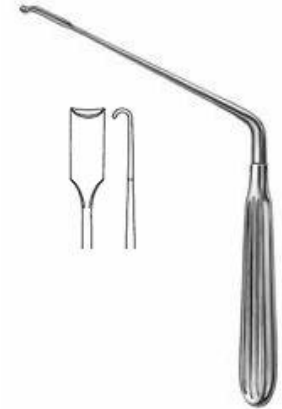

Scoville
RI-8-118-19
Nerve Root Retractor 7mm
16.5 cm,

Neurosurgery



Groningen
RI-8-119-26
Nerve Hook
26.5 cm,



Groningen
RI-8-120-26
Nerve Hook
26.5 cm,



Cushing
RI-8-121-19
Nerve Hook blunt
19 cm, 28 cm,

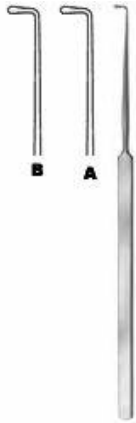

Cushing
RI-8-122-19
Nerve Hook
19.5 cm, 28 cm,



Smithwick
RI-8-123-17
Nerve Hook
17 cm, 21 cm,



Halle
RI-8-125-20
Dura Knife
20 cm,

Neurosurgery



Groningen
RI-8-119-26
Nerve Hook
26.5 cm,



Groningen
RI-8-120-26
Nerve Hook
26.5 cm,



Cushing
RI-8-121-19
Nerve Hook blunt
19 cm, 28 cm,

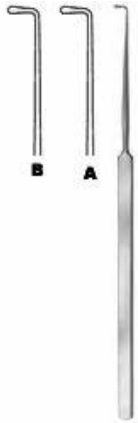

Cushing
RI-8-122-19
Nerve Hook
19.5 cm, 28 cm,



Smithwick
RI-8-123-17
Nerve Hook
17 cm, 21 cm,



Halle
RI-8-125-20
Dura Knife
20 cm,

Neurosurgery



Adson
RI-8-126-20
Dura Hook
20 cm,



Graham
RI-8-127-16
Dura Hook blunt
16.5 cm,



Sachs
RI-8-128-18
Dura Hook sharp
18 cm,



Toennis
RI-8-129-15
Dura Hook sharp
14.5 cm,



Frazier
RI-8-130-13
Dura Hook sharp
13 cm, 18 cm,



Krayenbuhl
RI-8-131-01
Nerve and Vessel Hooklet
18.5 cm Fig. 1, 18.5 cm Fig. 2,

Neurosurgery



Cloward
RI-8-132-16
 Lamina Spreader
 16 cm,

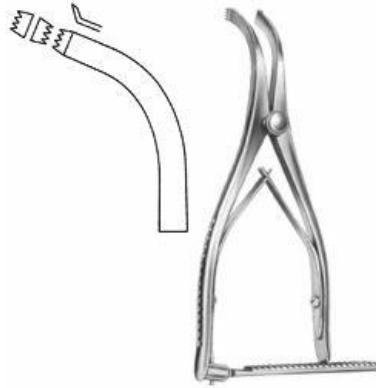

Inge
RI-8-133-17
 Lamina Spreader
 16 cm,

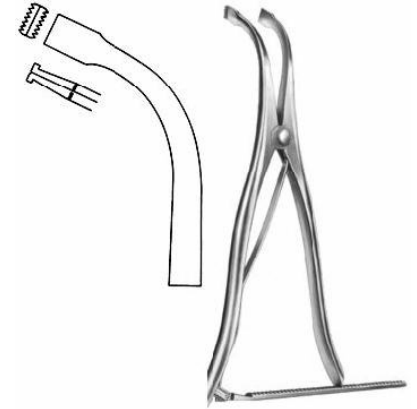

Inge
RI-8-134-27
 Lamina Spreader
 25.5 cm,

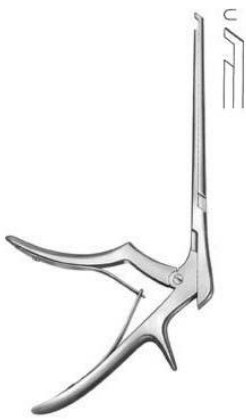

Ferris-Smith Kerrison
RI-8-135-03
 Laminectomy Punch 3mm downwards
 cutting 40 degree shaft length 180 mm

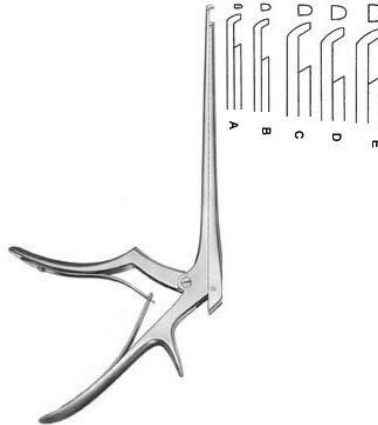

Ferris-Smith Kerrison
RI-8-138-01
 Laminectomy Punch upwards cutting shaft
 length 180 mm
 1 mm, 2 mm, 3 mm, 4 mm, 5 mm, 6 mm,

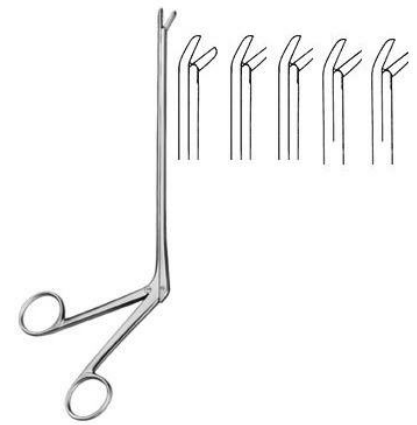

Cushing
RI-8-139-01
 Laminectomy Rongeur jaw 2 x 10 to 4 x 10
 mm straight shaft length 180 mm

Neurosurgery

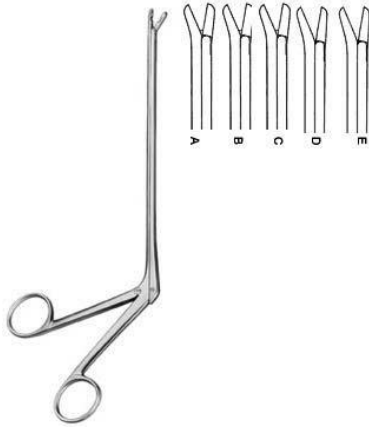

Cushing
RI-8-140-01

Laminectomy Rongeur jaw 2 x 10 to 4 x 10 mm upwards 45 degree shaft length 120 mm

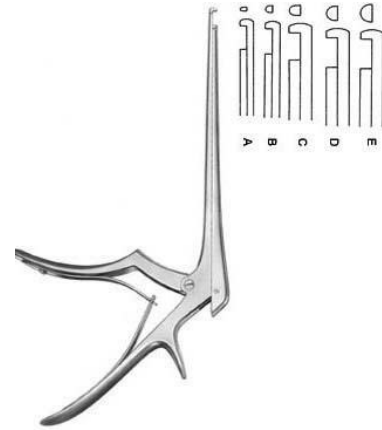

Ferris-Smith Kerrison
RI-8-137-01

Laminectomy Punch
1 mm, 2 mm, 3 mm, 4 mm, 5 mm, 6 mm,

Cardiovascular



RI-9-101-23
Bone Shear
23 cm,



RI-9-102-22
Rib Shear
23 cm,



Gluck
RI-9-103-22
Rib Shears
21 cm,



Giertz-Stille
RI-9-104-27
Rib Shear
24.5 cm,



Lebsche
RI-9-105-24
Sternum Chisel
24.5 cm,



RI-9-106-01
Rib Retractor lateral blades 12 x 16 mm
spreading 95 mm
Size 1,

Cardiovascular



Finochietto, Infant
RI-9-107-01

Rib Retractor lateral blades 15 x 15 mm
spreading 75 mm
Size 1,



Finochietto, Baby
RI-9-108-01

Rib Retractor lateral blades 31 x 31 mm
spreading 100 mm
Size 1,



Finochietto
RI-9-109-01

Rib Retractor lateral blades 40 x 45 mm
spreading 135 mm
Size 1,



Burford
RI-9-110-01

Rib Retractor with two pairs of blades 47 x 62 mm + 65 x 62 mm, spreading 200 mm
Size 1,



Castaneda
RI-9-111-01

Rib Retractor lateral blades 10,5 x 32 mm
spreading 65 mm
Size 1,



Finochietto (modif.)
RI-9-112-01

Rib Retractor lateral blades 14 x 15 mm
spreading 120 mm
Size 1,

Cardiovascular



Haight

RI-9-113-90

Rib Retractor lateral blades 30 x 30 mm
spreading 120 mm
Size 1,



Morse-Favaloro

RI-9-114-01

Sternal Retractor 4 movable blades 17 x 22
mm spreading 160 mm Sternal Retractor
Size 1,



Morse

RI-9-115-00

Sternal Retractor 4 movable blades 22 x 27
mm spreading 200 mm
Size 1,



Tuffier

RI-9-116-02

Rib Retractor lateral blades 22 x 27 mm
spreading 200 mm
Size 1,

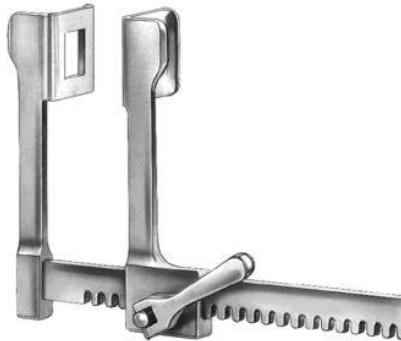

Finochietto, Baby

RI-9-117-75

Rib Retractor lateral blades 14 x 15 mm
spreading 75 mm
Size 1,



Finochietto

RI-9-118-01

Rib Retractor lateral blades 30 x 45 mm
spreading 150 mm
Size 1,

Cardiovascular



DeBakey
RI-9-119-00
Rib Retractor spreading 150 mm
Size 1,



DeBakey
RI-9-120-00
Rib Retractor spreading 200 mm
Size 1,



RI-9-121-00
Thoracic Retractor
Size 1,



Sellors
RI-9-122-19
Rib Contractor
20 cm,



Bailey-Baby
RI-9-123-14
Rib Contractor
15.5 cm,



Bailey
RI-9-124-16
Rib Contractor
20 cm,

Cardiovascular



Bailey-Gibbon
RI-9-125-16
Rib Contractor
20 cm,



Allison
RI-9-126-30
Lung Spatula
29.5 cm, 32.5 cm,



Price-Thomas
RI-9-127-22
Bronchus Clamp
22 cm,

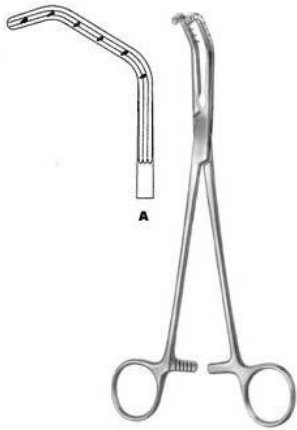

Price-Thomas
RI-9-128-22
Bronchus Clamp
22 cm,

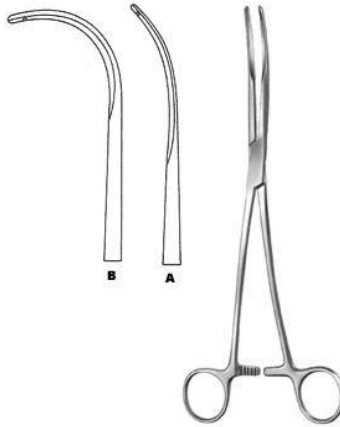

Semb
RI-9-129-24
Bronchus Clamp
24.5 cm,

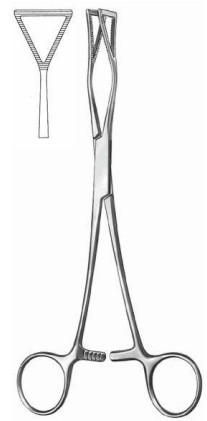

Lovelace
RI-9-130-20
Lung Grasping Forceps
20.5 cm,

Cardiovascular



Lovelace
RI-9-131-20
Lung Grasping Forceps
19 cm,



DeBakey-Satinsky
RI-9-132-07
Bulldog Clamp
7 cm, 9 cm,



Glover
RI-9-133-06
Bulldog Clamp
6 cm,



Santulli
RI-9-134-07
Bulldog Clamp
7 cm,



Gregory, soft
RI-9-135-09
Bulldog Clamp
9 cm, 11 cm,



Gregory
RI-9-136-01
Bulldog Clamp
10.5 cm,

Cardiovascular

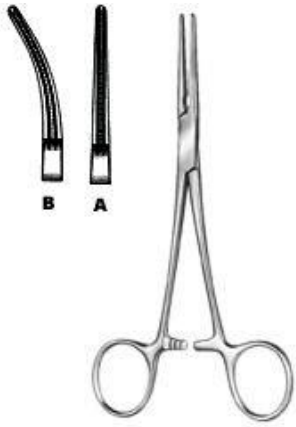

DeBakey-Rankin
RI-9-137-16
 Haemostatic Forceps
 16 cm,



DeBakey-Mosquito
RI-9-138-15
 Haemostatic Forceps
 15 cm,



Ochsner
RI-9-139-23
 Aortic Clamp
 23.5 cm,



Diethrich
RI-9-140-21
 Aortic Clamp
 22 cm,

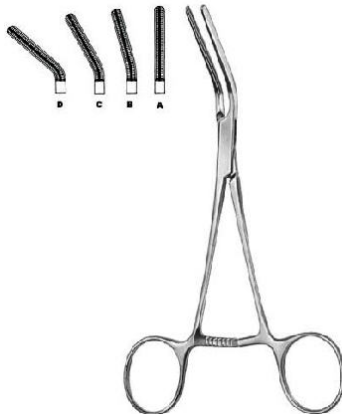

Dardik
RI-9-141-00
 Multi purpose Vascular Clamp
 15 cm,



Dale
RI-9-142-18
 Peripheral Vascular Clamp
 18 cm,

Cardiovascular

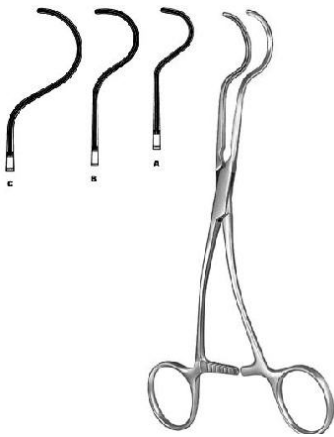

Dale
RI-9-143-17
 Peripheral Vascular Clamp
 17.5 cm,

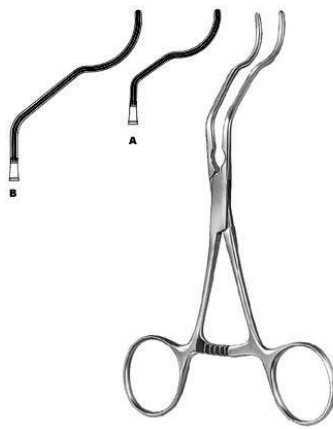

Gregory
RI-9-144-14
 Profunda Clamp
 13 cm, 16 cm, 18 cm,

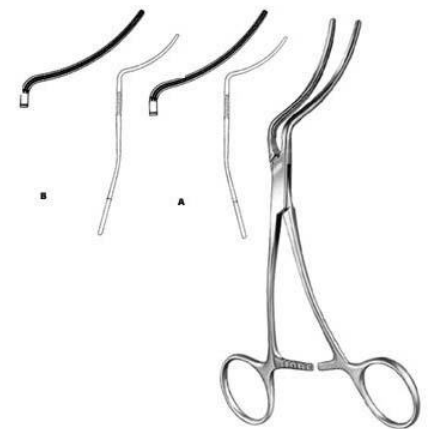

Martin
RI-9-145-16
 Peripheral Vascular Clamp
 16.5 cm,



Husfeldt
RI-9-146-18
 Peripheral Vascular Clamp
 17.5 cm,



Husfeldt
RI-9-147-18
 Peripheral Vascular Clamp
 18 cm,



Husfeldt
RI-9-148-17
 Peripheral Vascular Clamp
 17 cm,

Cardiovascular



DeBakey
RI-9-149-16
Vascular Forceps
16 cm,



DeBakey
RI-9-150-16
Vascular Forceps
16 cm,



DeBakey
RI-9-151-16
Vascular Forceps
16 cm,

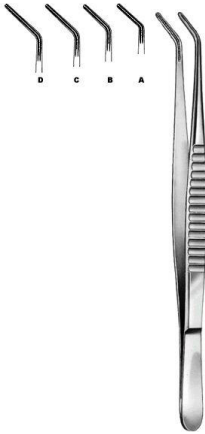

DeBakey
RI-9-152-16
Vascular Forceps
16 cm,



DeBakey
RI-9-153-16
Vascular Forceps
16 cm,



DeBakey
RI-9-154-07
Bulldog Clamp
7.5 cm,

Cardiovascular



DeBakey
RI-9-155-07
Bulldog Clamp
7.5 cm,



RI-9-156-23
Applying Forceps
23.5 cm,



Glover
RI-9-157-06
Bulldog Clamp
7 cm,



Glover
RI-9-158-06
Bulldog Clamp
6.5 cm,

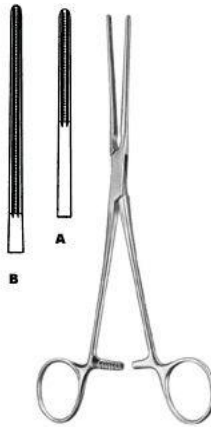

Potts
RI-9-159-21
Coarctation Clamp
21 cm,

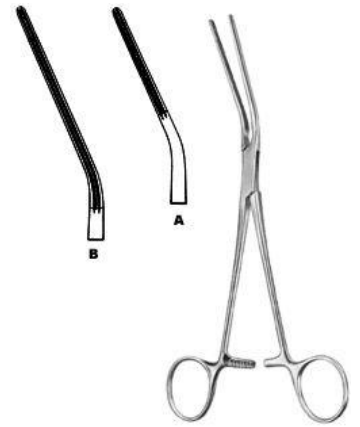

Potts
RI-9-160-21
Coarctation Clamp
20.5 cm,

Cardiovascular

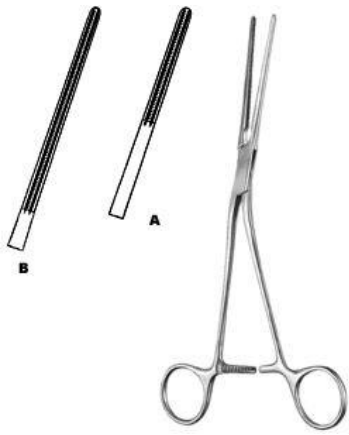

Potts
RI-9-161-21
 Coarctation Clamp
 20.5 cm,



Potts
RI-9-162-22
 Anastomosis Clamp
 21.5 cm,



Potts
RI-9-163-22
 Anastomosis Clamp
 22 cm,

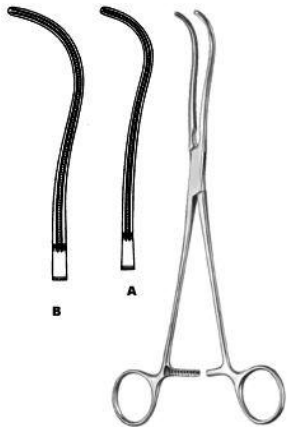

DeBakey
RI-9-164-19
 Ligature Forceps
 19 cm,



DeBakey
RI-9-165-16
 Peripheral Vascular Clamp
 16 cm,



DeBakey
RI-9-166-19
 Peripheral Vascular Clamp
 16 cm,

Cardiovascular

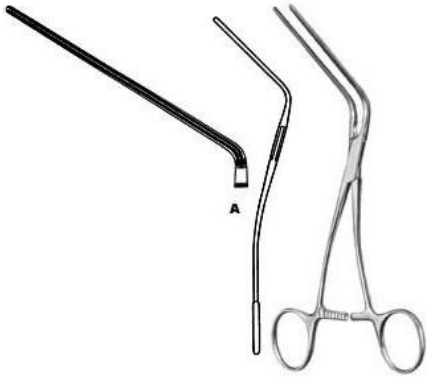

Leland-Jones
RI-9-167-18
 Peripheral Vascular Clamp
 18 cm,



Bainbridge
RI-9-168-15
 Multi purpose Vascular Clamp
 15 cm,



Bainbridge
RI-9-169-15
 Multi purpose Vascular Clamp
 15 cm,

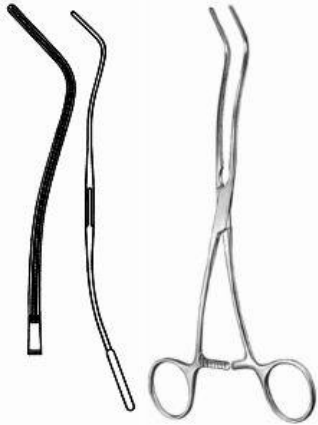

DeBakey
RI-9-170-20
 Multi purpose Vascular Clamp
 20 cm,



DeBakey
RI-9-171-26
 Aortic Aneurysm Clamp
 26 cm,



DeBakey
RI-9-172-28
 Aortic Aneurysm Clamp
 28 cm,

Cardiovascular



DeBakey
RI-9-173-30
Aortic Aneurysm Clamp
30 cm,



DeBakey
RI-9-174-27
Aortic Clamp
27 cm,



DeBakey
RI-9-175-24
Ligature Forceps
24.5 cm,



DeBakey
RI-9-176-24
Ligature Forceps
24.5 cm,



DeBakey
RI-9-178-25
Ligature Forceps
27 cm,

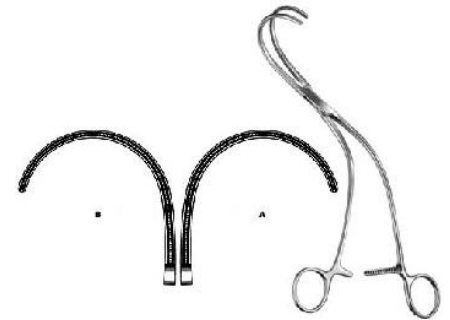

Weber
RI-9-179-01
Aortic Clamp
24 cm,

Cardiovascular



Satinsky

RI-9-180-20

Tangential Occlusion Clamp
22 cm,



Harken

RI-9-181-01

Auricle Clamp
24.5 cm,



Lees

RI-9-182-23

Bronchus Clamp
23 cm,



Lees

RI-9-183-25

Bronchus Clamp
25 cm,



Lambert-Kay

RI-9-184-21

Anastomosis Clamp
22.5 cm,



DeBakey

RI-9-185-17

Anastomosis Clamp
16.5 cm,

Cardiovascular



Morris-DeBakey
RI-9-186-18
 Aortic Clamp
 16.5 cm,



DeBakey-Bahnson
RI-9-187-23
 Aneurysm Clamp
 23.5 cm,

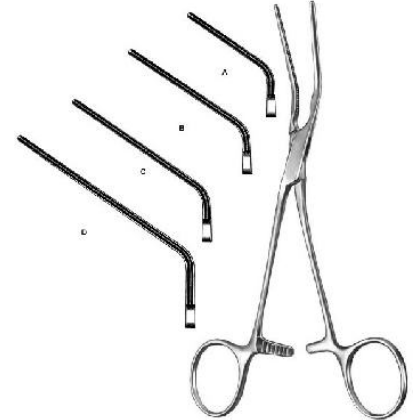

DeBakey
RI-9-188-20
 Multi purpose Vascular Clamp
 18 cm,

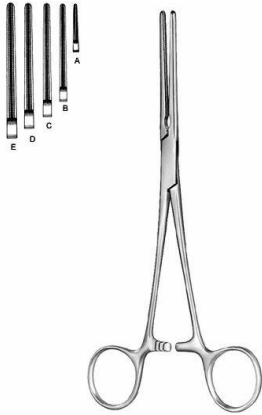

DeBakey-Mosquito
RI-9-189-12
 Haemostatic Forceps
 12.5 cm,



DeBakey-Mosquito
RI-9-190-12
 Haemostatic Forceps
 12.5 cm,



DeBakey
RI-9-191-17
 Multi purpose Vascular Clamp
 17 cm,

Cardiovascular



DeBakey
RI-9-192-16

Multi purpose Vascular Clamp
16.5 cm,

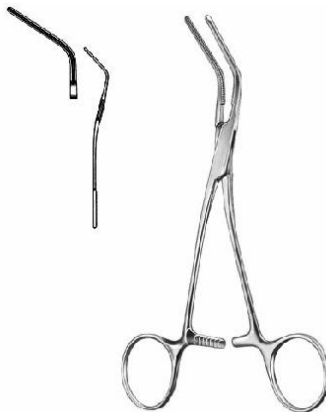

DeBakey
RI-9-193-15

Multi purpose Vascular Clamp
16 cm,

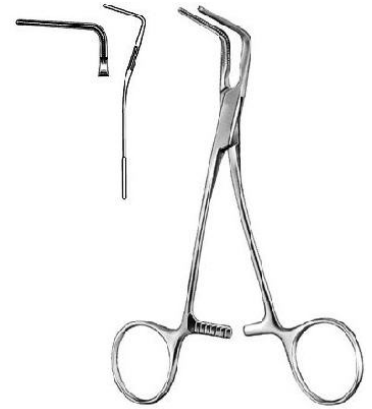

DeBakey
RI-9-194-15

Multi purpose Vascular Clamp
16.5 cm,



DeBakey
RI-9-195-17

Multi purpose Vascular Clamp
16.5 cm,



Glover
RI-9-196-17

Multi purpose Vascular Clamp
17 cm,



Glover
RI-9-197-17

Multi purpose Vascular Clamp
17.5 cm,

Cardiovascular



DeBakey
RI-9-192-16

Multi purpose Vascular Clamp
16.5 cm,

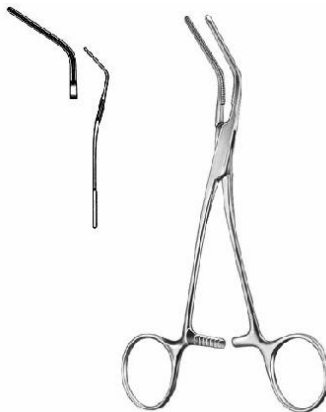

DeBakey
RI-9-193-15

Multi purpose Vascular Clamp
16 cm,

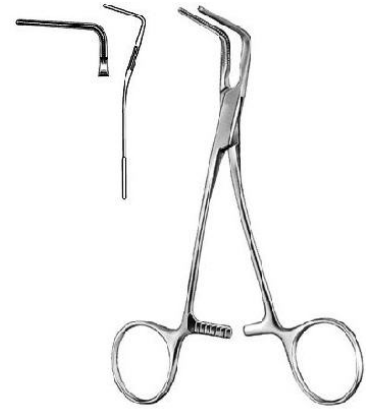

DeBakey
RI-9-194-15

Multi purpose Vascular Clamp
16.5 cm,



DeBakey
RI-9-195-17

Multi purpose Vascular Clamp
16.5 cm,



Glover
RI-9-196-17

Multi purpose Vascular Clamp
17 cm,



Glover
RI-9-197-17

Multi purpose Vascular Clamp
17.5 cm,

Cardiovascular

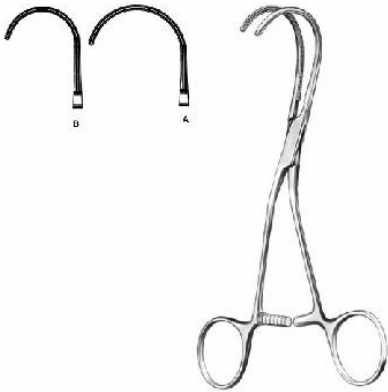

DeBakey
RI-9-198-16
 Multi purpose Vascular Clamp
 16.5 cm,

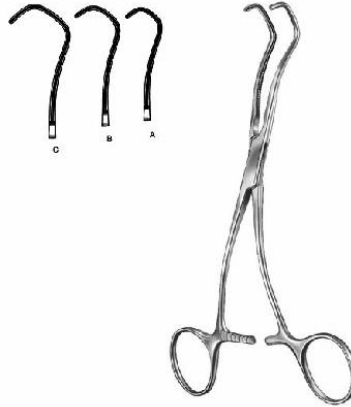

Derra
RI-9-199-16
 Anastomosis Clamp
 16.5 cm Fig. 1, 17 cm Fig. 2, 18 cm Fig. 3,



DeBakey-Beck
RI-9-200-17
 Anastomosis Clamp
 17 cm,



Cooley
RI-9-201-16
 Vascular Forceps
 16 cm,

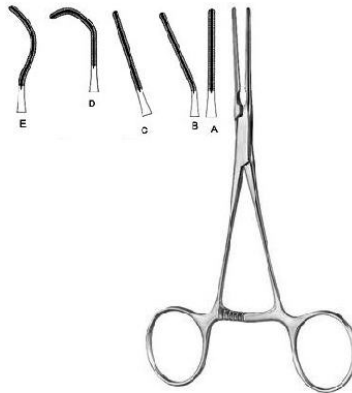

Cooley
RI-9-202-01
 Pediatric Vascular Clamp
 14.5 cm,



Cooley
RI-9-203-21
 Iliac Clamp
 22 cm,

Cardiovascular



Cooley
RI-9-204-17
Anastomosis Clamp
17 cm,

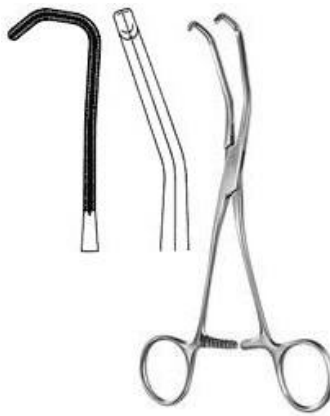

Cooley
RI-9-205-17
Anastomosis Clamp
20 cm,



Cooley
RI-9-206-16
Anastomosis Clamp
17 cm,



Cooley
RI-9-207-15
Multi purpose Vascular Clamp
16 cm,



Cooley
RI-9-208-17
Multi purpose Vascular Clamp
17 cm,



Cooley
RI-9-209-17
Multi purpose Vascular Clamp
17 cm,

Cardiovascular



Cooley
RI-9-210-17
Multi purpose Vascular Clamp
17.5 cm,

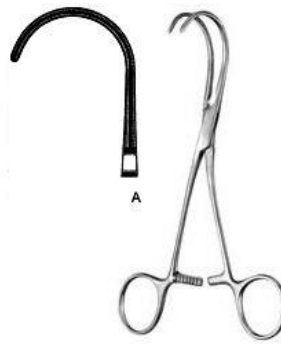

Cooley
RI-9-211-16
Multi purpose Vascular Clamp
16.5 cm,



Cooley-Derra
RI-9-212-16
Anastomosis Clamp
16.5 cm,



Cooley-Beck
RI-9-213-17
Anastomosis Clamp
17 cm,

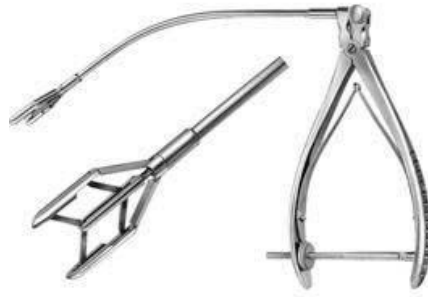

Cooley
RI-9-214-00
Aortic Dilator



Cooley
RI-9-215-05
Vascular Dilator
13 cm 0,5 mm ?,

Cardiovascular



DeBakey
RI-9-216-05
Vascular Dilator
19 cm 0,5 mm ?



Martin
RI-9-217-00
Tunneling Set complete set with three shafts, two handles and 12 tips in storage case.



Hach
RI-9-218-01
Fasciotomy Knife with plastic handle
30 cm,



RI-9-219-18
Intima Spatula
18.5 cm,

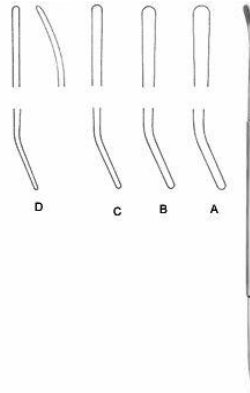

Robb
RI-9-220-01
Vascular Dissector
24 cm Fig. 1 2,5 mm ?, 24 cm Fig. 2 2,0 mm ?



Crile
RI-9-221-20
Nerve Hooklet
20 cm,

Cardiovascular

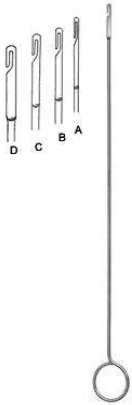

RI-9-222-15
Ligature Catcher
26 cm 1,5 mm,



Subramanian-Miniature
RI-9-223-15
Aortic Clamp 135 degree
15.5 cm,

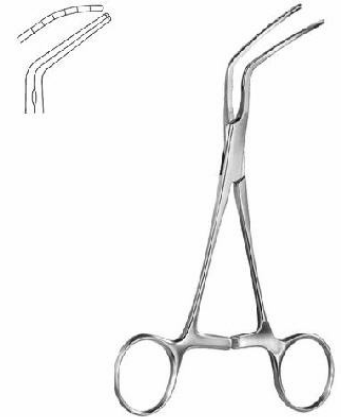

Subramanian
RI-9-224-16
Aortic Clamp
16 cm,

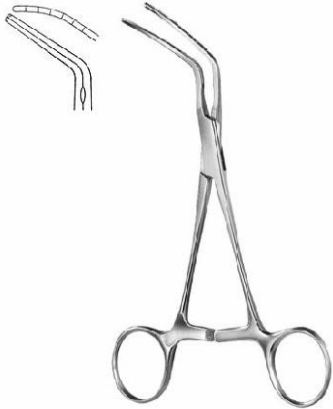

Subramanian
RI-9-225-16
Aortic Clamp
13.5 cm Fig. 1, 13.5 cm Fig. 2, 14 cm Fig. 3,

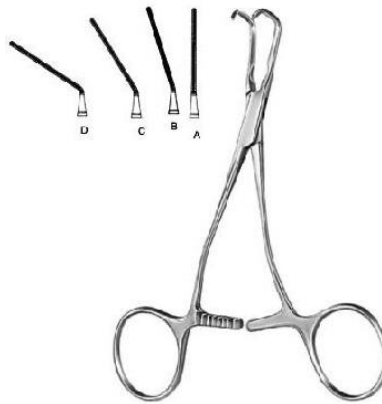

RI-9-226-01
Pediatric Vascular Clamp



RI-9-227-16
Pediatric Vascular Clamp
16.5 cm,

Cardiovascular



RI-9-228-16
Pediatric Vascular Clamp
16 cm,

Ophthalmology



Barraquer (Colibri)
RI-11-101-03
Barraquer
Size 1,

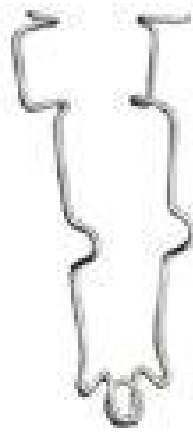

RI-11-102-07
Bowman
Size 1,

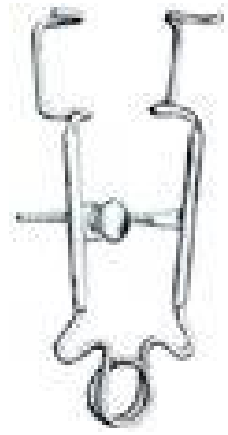

RI-11-103-06
Critchett
Size 1,



RI-11-104-05
Smith
Size 1,



RI-11-105-08
Clark
Size 1,



RI-11-106-06
Graefe
Size 1,

Ophthalmology



RI-11-107-08
Week
Size 1,



RI-11-108-07
Arruga
Size 1,



RI-11-109-07
Arruga
Size 1,



RI-11-110-05
Murdock
Size 1,



Millinger
RI-11-111-07
Mellinger Axenfeld
Size 1,



Millinger
RI-11-112-07
Mellinger Axenfeld
Size 1,

Ophthalmology



Millenger
RI-11-113-07
Mellinger
Size 1,



RI-11-114-08
Lister Burch
Size 1,



Williams Eye Speculum
RI-11-115-08
Williams
7 cm, 8.3 cm,



Lancaster
RI-11-116-07
Lancaster
Size 1,



RI-11-118-08
Ziegler
Size 1,



Mueller
RI-11-120-07
Mueller
Size 1,

Ophthalmology



Jaeger Lid Plate
RI-11-121-11
 Jaeger
 4", 20mm, 23mm,



VON GRAEFE Knife
RI-11-122-03
 Graefe
 1, 2, 3, 4, 5,



RI-11-123-01
 Jaeger
 Size 1,



RI-11-124-13
 Berens
 Size 1,



ZIEGLER knife Needle
RI-11-126-01
 Ziegler
 11.4 cm,



Castroviejo Cyclodialysis Spatula
RI-11-127-12
 Castroviejo
 13.3 cm,

Ophthalmology



RI-11-128-12
Wheeler
Size 1,



Castroviejo Cycloidalysis Spatula
RI-11-129-05
Castroviejo
Size 1,



RI-11-130-12
Dix
Size 1,



RI-11-131-13
Dix
Size 1,



RI-11-132-13
Dix
Size 1,



Castroviejo Caliper
RI-11-133-07
Castroviejo
8.3 cm,

Ophthalmology



RI-11-134-13
Connin Amsler
Size 1,



RI-11-135-06
Dastoor
Size 1,



RI-11-136-09
Holtz
Size 1,



Wilder Lacrimal Dilator
RI-11-137-03
Wilder
10.2 cm,



ZIEGLER Lacrimal Dilator
RI-11-138-12
Ziegler
14 cm Double End,



Castroviejo Lacrimal Dilator
RI-11-139-12
Castroviejo
14 cm,

Ophthalmology



RI-11-140-78
Bowman
Size 1,



RI-11-141-07
Graefe
Size 1,



RI-11-142-07
Graefe
Size 1,



RI-11-143-07
Graefe
Size 1,



RI-11-144-07
Graefe
Size 1,



RI-11-145-07
Fischer
Size 1,

Ophthalmology



RI-11-146-07
Barraquer Katzin
Size 1,



RI-11-147-07
Troutman
Size 1,



RI-11-148-07
Barraquer
Size 1,



RI-11-149-07
Barraquer
Size 1,



RI-11-150-09
McCullough
Size 1,



RI-11-151-09
McCullough
Size 1,

Ophthalmology



RI-11-152-10
Jameson
Size 1,



RI-11-153-10
Jameson
Size 1,



RI-11-154-10
Bonaccolto
Size 1,



RI-11-155-10
Bonaccolto
Size 1,



RI-11-156-10
Dastoor
Size 1,



RI-11-157-10
Dastoor
Size 1,

Ophthalmology



RI-11-158-05
Bishop Harman
Size 1,



RI-11-159-08
Bishop Harman
Size 1,



RI-11-160-05
Bishop Harman
Size 1,



RI-11-161-08
Bishop Harman
Size 1,



RI-11-162-07
Mod Bonn
Size 1,



RI-11-163-07
Mod Bonn
Size 1,

Ophthalmology



RI-11-164-10
Mod Bonn
Size 1,



RI-11-165-10
Mod Bonn
Size 1,



RI-11-166-10
Mod Bonn
Size 1,



RI-11-167-10
Mod Bonn
Size 1,



RI-11-168-10
Prince
Size 1,



RI-11-169-10
Prince
Size 1,

Ophthalmology



RI-11-170-20
Berke
Size 1,



RI-11-171-08
Troutman
Size 1,



RI-11-172-05
Barraquer
Size 1,



RI-11-173-11
Elsching
Size 1,



RI-11-174-11
Graefe
Size 1,



RI-11-175-09
Lester
Size 1,

Ophthalmology



RI-11-176-09
Castroviejo
Size 1,



RI-11-178-09
Castroviejo
Size 1,



RI-11-179-09
Barraquer
Size 1,



RI-11-180-10
Green
Size 1,



RI-11-181-07
Gill Arruga
Size 1,



RI-11-182-01
Castroviejo
Size 1,

Ophthalmology



RI-11-183-05
Castroviejo
Size 1,



RI-11-184-10
Moorfield
Size 1,



RI-11-185-07
St Martin
Size 1,



RI-11-186-10
Mod Tubingen
Size 1,



RI-11-187-10
McPherson
Size 1,



RI-11-188-10
McPherson
Size 1,

Ophthalmology



RI-11-189-09
Ayer
Size 1,



RI-11-190-09
Ayer
Size 1,



RI-11-191-09
Desmarres
Size 1,



RI-11-192-10
Snellen
Size 1,



RI-11-1193-11
Knapp Luer
Size 1,



RI-11-194-28
Scheie
Size 1,

Ophthalmology



RI-11-195-45
Mod Tubingen
Size 1,



RI-11-196-00
Elliot
Size 1,



RI-11-197-09
Beer
Size 1,

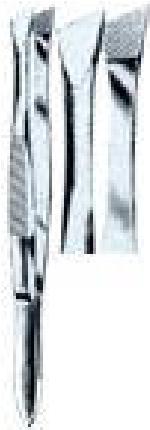

RI-11-198-10
Barraquer

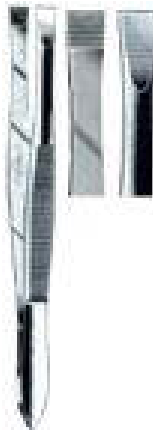

RI-11-199-09
Douglas
Size 1,



RI-11-200-09
Gradle
Size 1,

Ophthalmology



RI-11-177-09
Castroviejo
Size 1,

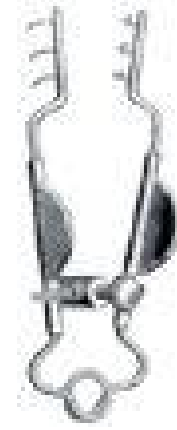

RI-11-119-07
Mueller
Size 1,

Tracheotomy

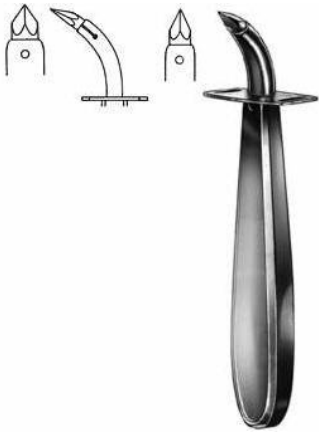

Ueckermann
RI-16-101-13
Tracheotomy Trocar
11.5 cm,



Iterson
RI-16-102-16
Tracheal Hook
17 cm,



Rose
RI-16-103-13
Tracheal Hook
13.5 cm,



Luer
RI-16-104-11
Tracheal Hook
11 cm,



RI-16-105-15
Tracheal Hook
15 cm,



Lukens
RI-16-106-17
Thymus Retractor
17.5 cm,

Tracheotomy



Jackson
RI-16-107-17
Tracheal Hook
18 cm,



Kocher
RI-16-108-15
Goitre Enucleator
16.5 cm,



Kocher
RI-16-109-15
Goitre Enucleator
16.5 cm,



Hofmeister
RI-16-110-21
Goitre Enucleator
20.5 cm,

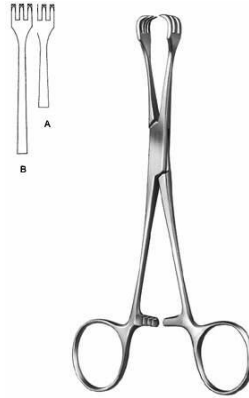

Lahey
RI-16-111-15
Goitre Grasping Forceps
15.5 cm,



Luer
RI-16-112-04
Tracheal Tube

Tracheotomy



Luer
RI-16-113-08
Tracheal Tube



Chevalier-Jackson
RI-16-114-04
Tracheal Tube outer tube closed inner tube
closed silver



RI-16-115-08
Speaking Tube

Dermatology



Moncorps
RI-17-101-14
Milium Knife
14 cm,



Moncorps
RI-17-102-00
Spare Blade



Vidal
RI-17-103-14
Lupus Scraper
13 cm,



Wolff
RI-17-105-01
Lupus Curette
14 cm,



Kilner
RI-17-106-15
Skin Hooklet
14.5 cm,



Gillies
RI-17-107-18
Skin Hooklet
18 cm,

Dermatology



Kaye
RI-17-108-03
 Face-lift Hook
 13 cm,

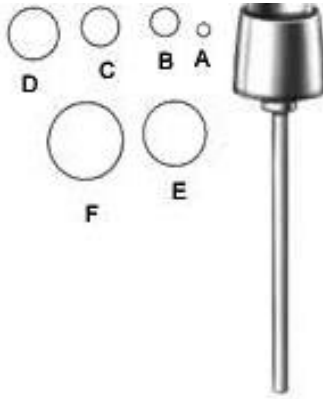

RI-17-109-02
 Dermal Punch
 5.5 cm,



Handle
RI-17-110-00
 8 cm,

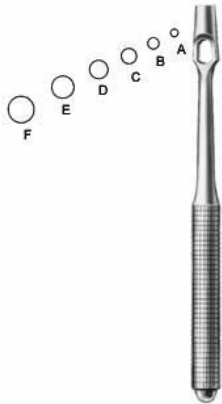

Keyes
RI-17-111-02
 Dermal Punch
 11 cm,



Unna
RI-17-113-14
 Comedone Extractor
 14.5 cm,



Saalfeld
RI-17-114-10
 Comedone Extractor
 11 cm,

Dermatology



Saalfeld
RI-17-115-14
Saalfeld Comedone Extractor
14.5 cm,



Schamberg
RI-17-116-10
Comedone Extractor
9.5 cm,



Katsch
RI-17-117-14
Comedone Extractor
16 cm,



Unna-Vidal
RI-17-118-11
Comedone Extractor
11.5 cm,



d'Assump?
RI-17-119-15
Face-lift Forceps
18 cm,

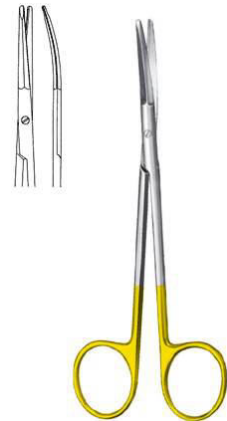

Gregory
RI-17-120-14
Face-lift Scissors
14 cm,

Dermatology

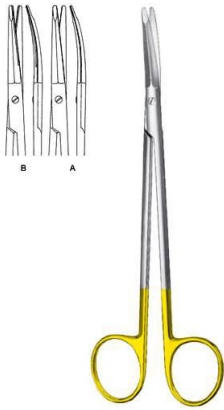

Kaye
RI-17-121-15
 Face-lift Scissors
 15 cm, 18 cm,



Stella-S
RI-17-122-18
 Face-lift Scissors
 18 cm,

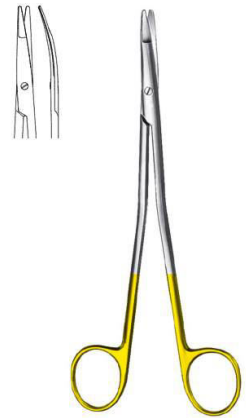

Gorney
RI-17-123-18
 Face-lift Scissors
 18 cm,

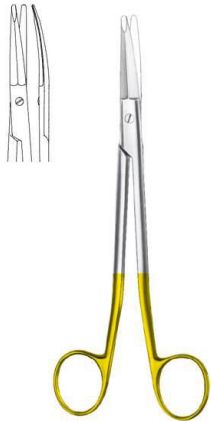

Freeman-Kaye
RI-17-124-18
 Face-lift Scissors
 18 cm,

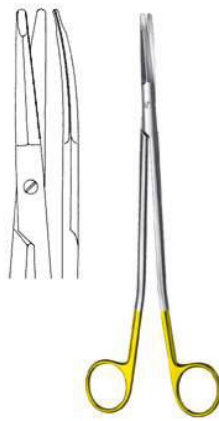

Freeman
RI-17-125-00
 Face-lift Scissors
 23 cm,



Fox
RI-17-104-01
 Lupus Curette
 14 cm,

Dermatology

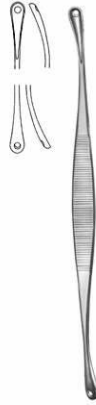

Unna
RI-17-112-14
Comedone Extractor
14.5 cm,

Intestines & Stomach



Allis-Baby
RI-18-101-12

Intestinal and Tissue Grasping Forceps
13 cm,

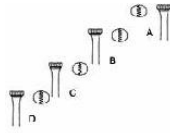

Allis
RI-18-102-15

Intestinal and Tissue Grasping Forceps
15.5 cm, 19 cm, 25.5 cm,



Allis
RI-18-103-16

Intestinal and Tissue Grasping Forceps
15.5 cm, 20 cm, 24.5 cm, 30 cm,



Allis-Adair
RI-18-104-15

Intestinal and Tissue Grasping Forceps
16 cm,



Boys-Allis
RI-18-105-15

Intestinal and Tissue Grasping Forceps
15.5 cm,



Thoms-Allis
RI-18-106-20

Intestinal and Tissue Grasping Forceps
20.5 cm,

Intestines & Stomach



Allis
RI-18-107-20

Intestinal and Tissue Grasping Forceps
20 cm,

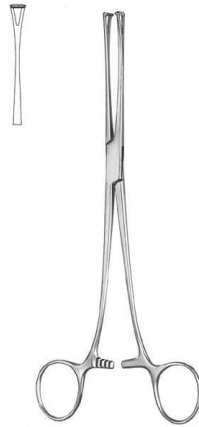

Lockwood
RI-18-108-20

Intestinal and Tissue Grasping Forceps
20 cm,



Williams
RI-18-109-16

Intestinal and Tissue Grasping Forceps
16.5 cm,

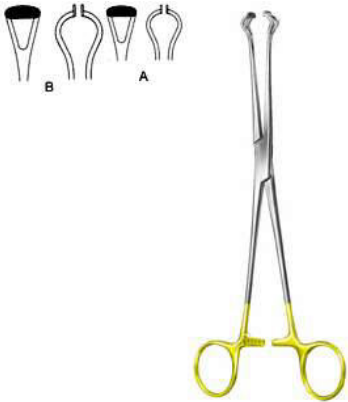

Babcock
RI-18-110-16

Intestinal and Tissue Grasping Forceps
16.5 cm, 21 cm,

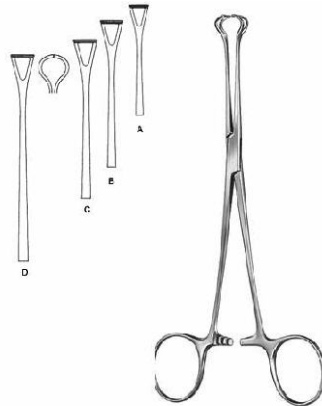

Babcock
RI-18-111-16

Intestinal and Tissue Grasping Forceps
15.5 cm, 17.5 cm, 21 cm, 24 cm,

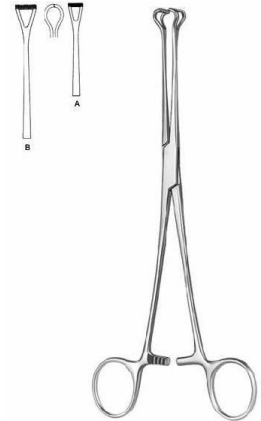

Babcock
RI-18-112-16

Intestinal and Tissue Grasping Forceps
16 cm, 20.5 cm,

Intestines & Stomach



Duval

RI-18-113-20

Intestinal and Tissue Grasping Forceps
20.5 cm,

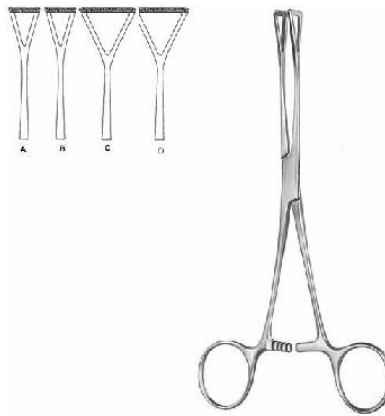

Duval

RI-18-114-18

Intestinal and Tissue Grasping Forceps
18 cm, 20.5 cm, 23 cm,

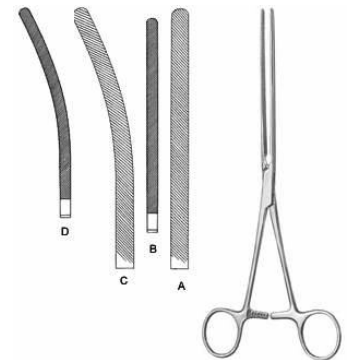

Doyen

RI-18-115-21

Intestinal Clamp
21.5 cm, 23.5 cm,

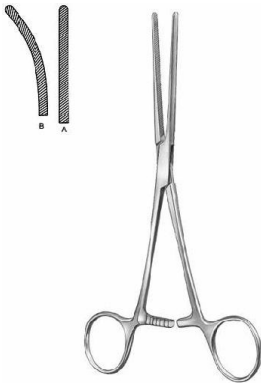

Doyen-Baby

RI-18-116-18

Intestinal Clamp
18 cm, 17.5 cm,

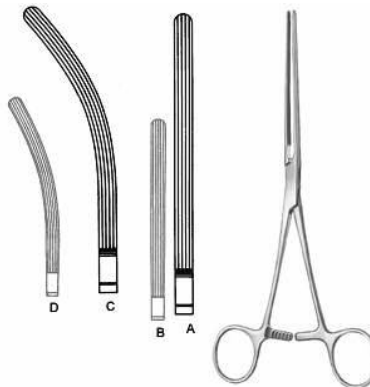

Mayo-Robson

RI-18-117-21

Intestinal Clamp
21.5 cm, 23.5 cm, 23 cm,

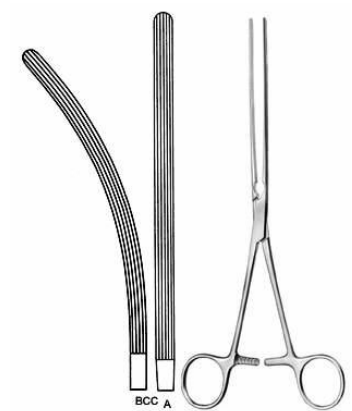

Mayo-Robson

RI-18-118-25

Intestinal Clamp
25.5 cm, 24.5 cm,

Intestines & Stomach

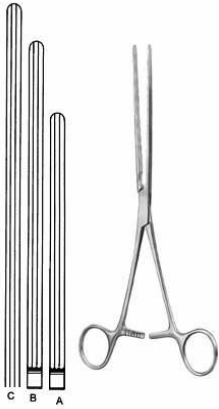

Kocher
RI-18-119-22
 Intestinal Clamp
 22.5 cm, 25 cm, 28.5 cm,

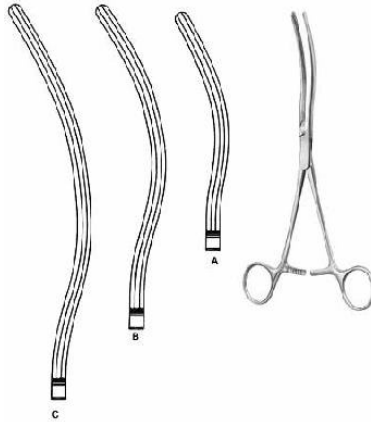

Kocher
RI-18-120-22
 Intestinal Clamp
 22 cm, 24.5 cm, 27.5 cm,



Allen
RI-18-121-16
 Intestinal Clamp
 16 cm,



Payr-Baby
RI-18-122-15
 Intestinal and Pylorus Clamp
 15 cm,

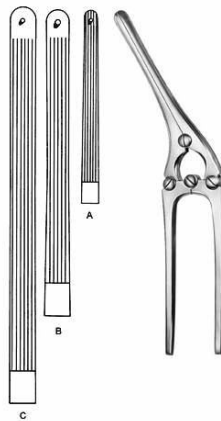

Payr
RI-18-123-21
 Intestinal and Pylorus Clamp
 20.5 cm, 29 cm, 34.5 cm,



Stone-Watt
RI-18-124-07
 Intestinal Anastomosis Clamp
 8.5 cm, 10 cm,

Intestines & Stomach



Stone-Watt
RI-18-125-15
 Closing Forceps

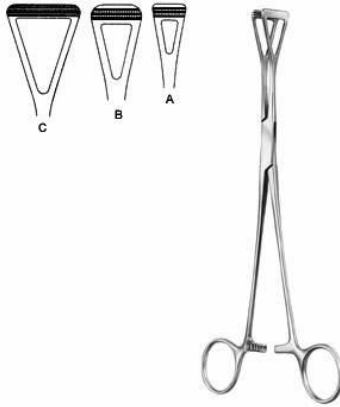

Scheibe
RI-18-126-18
 Organ Grasping Forceps
 18 cm,

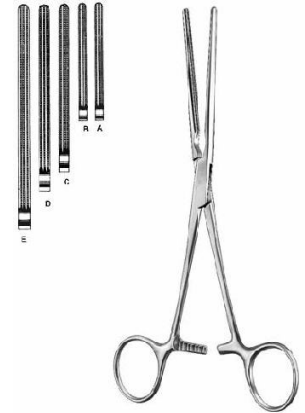

Doyen-Baby
RI-18-127-13
 Intestinal Clamp
 14 cm, 17 cm,

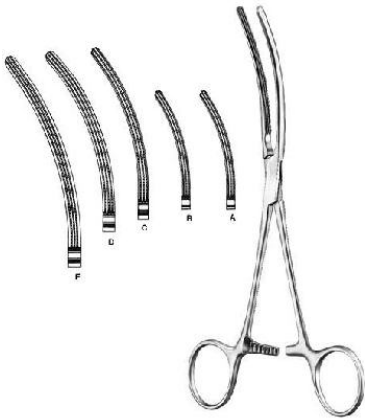

Doyen-Baby
RI-18-128-13
 Intestinal Clamp
 13.5 cm, 17 cm,



Mayo-Robson
RI-18-129-25
 Intestinal Clamp
 26 cm,



Mayo-Robson
RI-18-130-25
 Intestinal Clamp
 25 cm,

Intestines & Stomach

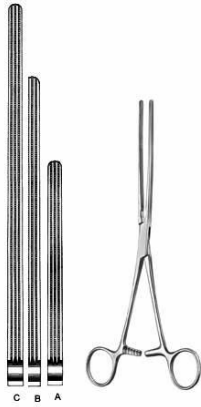

Kocher
RI-18-131-22
 Intestinal Clamp
 22.5 cm, 28 cm,

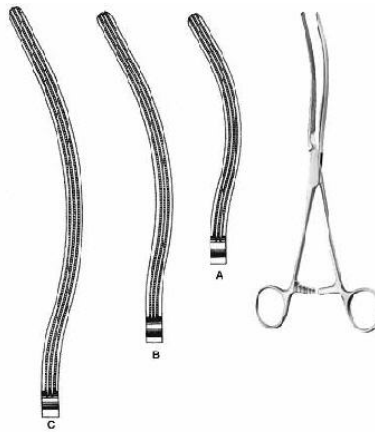

Kocher
RI-18-132-22
 Intestinal Clamp
 22 cm, 25 cm, 27.5 cm,

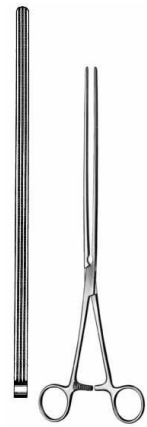

Scudder
RI-18-133-33
 Intestinal Clamp
 33.5 cm,

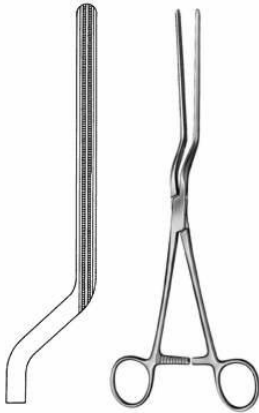

Brunner
RI-18-134-24
 Sigmoid Anastomosis Forceps
 27 cm,

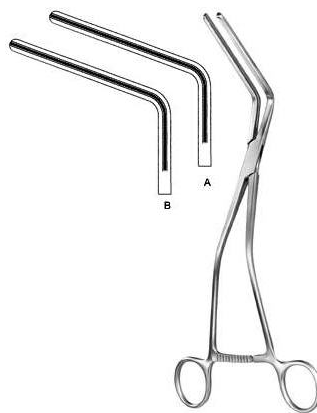

Hayes
RI-18-135-26
 Sigmoid Anastomosis Forceps
 27 cm, 28 cm,



Veidheimer
RI-18-136-23
 Sigmoid Anastomosis Forceps
 25 cm,

Intestines & Stomach



Fehland
RI-18-137-24
Sigmoid Anastomosis Forceps
24 cm,

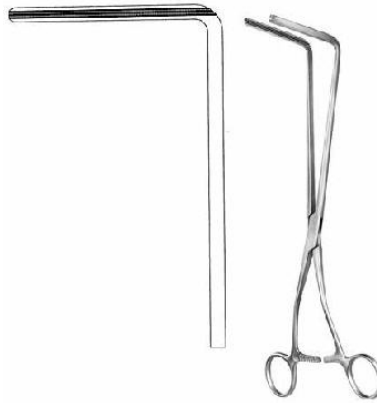

Resano
RI-18-138-30
Sigmoid Anastomosis Forceps
28 cm,



Sims
RI-18-139-15
Rectal Speculum
15.5 cm,



Sims
RI-18-140-15
Rectal Speculum
15.5 cm,



Mathieu
RI-18-141-19
Rectal Speculum
19 cm,



Alan-Parks
RI-18-142-00
Alan-Parks
14 cm,

Intestines & Stomach



McGinvey

RI-18-143-19

Hemorrhoidal Grasping Forceps
19 cm,



RI-18-144-00

Handle for biopsy forceps



RI-18-145-38

Rectal Biopsy Forceps

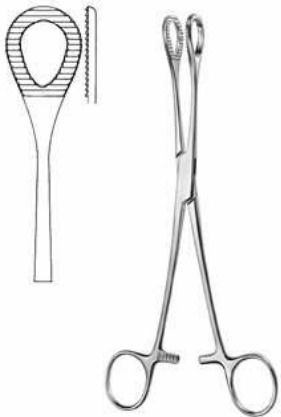

Heywood-Smith

RI-18-146-21

Polypus Grasping Forceps
21 cm,

Urology

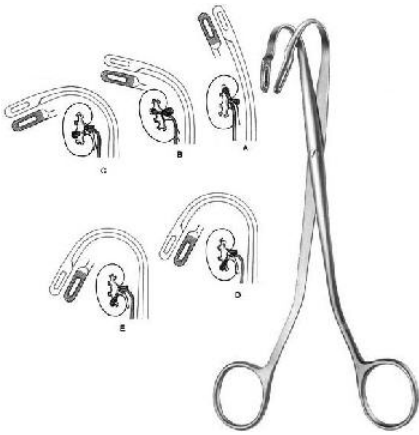

Randall

RI-19-101-23 A

Kidney Stone Forceps
23 cm Fig. 1, 21 cm Fig. 2, 19 cm Fig. 3,

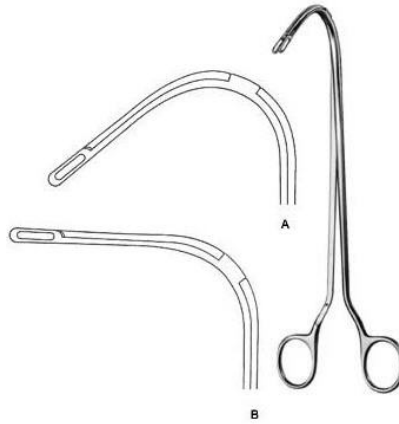

Randall

RI-19-102-23 A

Kidney Stone Forceps
23 cm, 24.5 cm,

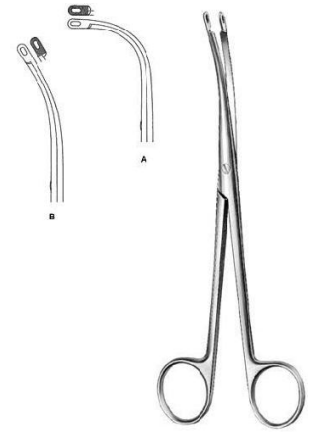

Heiming

RI-19-103-16 A

Kidney Stone Forceps
16 cm Fig. 1, 17 cm Fig. 2,

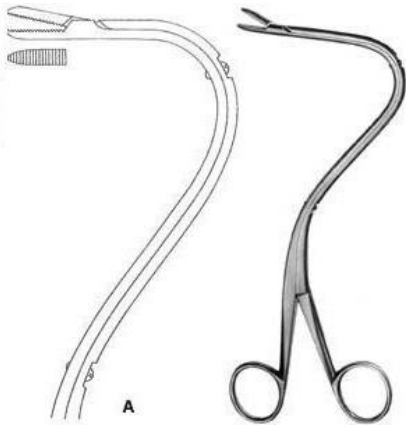

Elsasser

RI-19-104-01 A

Nephrostomy Forceps
21 cm Fig. 1, 21 cm Fig. 2,



Bakes

RI-19-105-01 A

Gall Duct Dilator
32 cm,

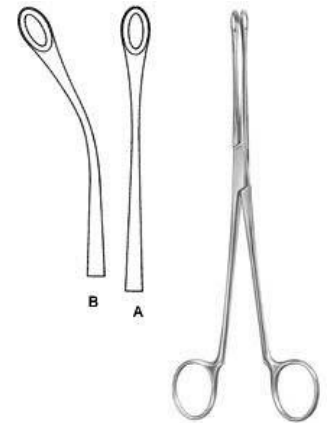

Blake

RI-19-106-20 A

Gall Stone Forceps
21 cm,

Urology



Mayo-Blake
RI-19-107-20
Gall Stone Forceps
21 cm,



Mayo-Blake
RI-19-108-20
Gall Stone Forceps
21 cm,



Mixer
RI-19-109-22
Gall Stone Forceps
21.5 cm,



Desjardins
RI-19-110-23 A
Gall Stone Forceps
23 cm,

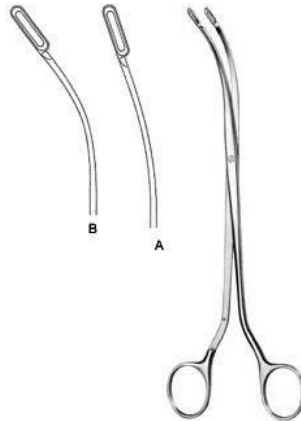

Desjardins
RI-19-111-24 A
Gall Stone Forceps



Luer-Korte
RI-19-112-01 A
Gall Stone Scoop
32 cm Fig. 0, 32 cm Fig. 00, 32 cm Fig.
000, 32 cm Fig. 1, 32 cm Fig. 2, 32 cm Fig.
3, 32 cm Fig. 4,

Urology

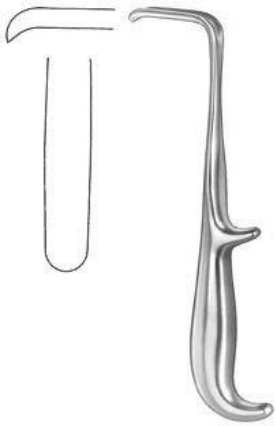

Young
RI-19-113-21
Prostatic Retractor
21.5 cm,



Young
RI-19-114-22
Prostatic Retractor
20.5 cm,



Young
RI-19-115-21
Prostatic Retractor
22 cm,

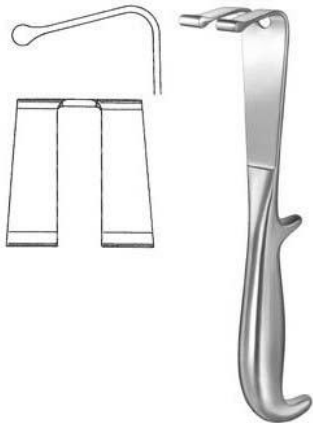

Young
RI-19-116-22
Prostatic Retractor
21.5 cm,



Millin
RI-19-117-24
Capsule Forceps
24.5 cm,

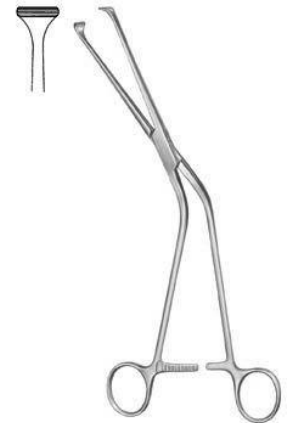

Millin
RI-19-118-24
Capsule Forceps
22 cm,

Urology

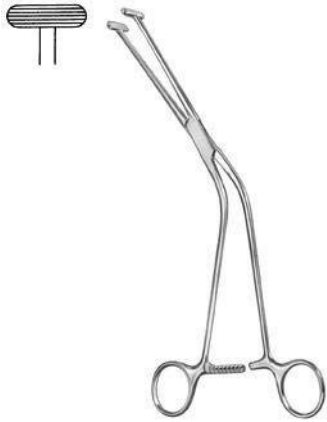

Millin
RI-19-119-23
Capsule Forceps
24.5 cm,

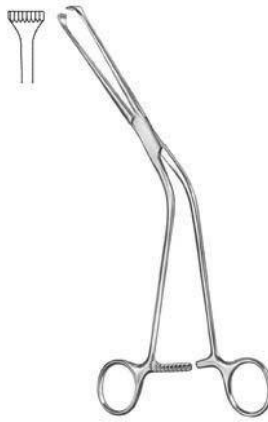

Millin
RI-19-120-23
Capsule Forceps
22 cm,

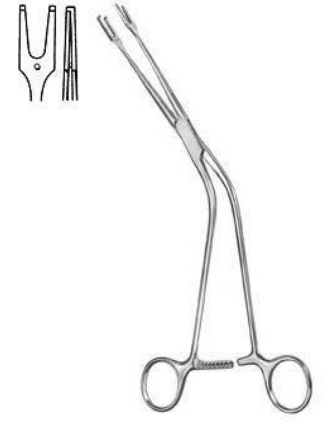

Millin
RI-19-121-24
Ligature Carrying Forceps
24.5 cm,



Millin
RI-19-122-00
Bladder Neck Spreader
29,



Thomson-Walker
RI-19-123-00
Bladder Retractor



Judd-Masson
RI-19-124-00
Bladder Retractor

Urology



Millin
RI-19-125-00 A
Bladder Retractor



Legueu
RI-19-126-27
Bladder Spatula
24 cm 35 mm,

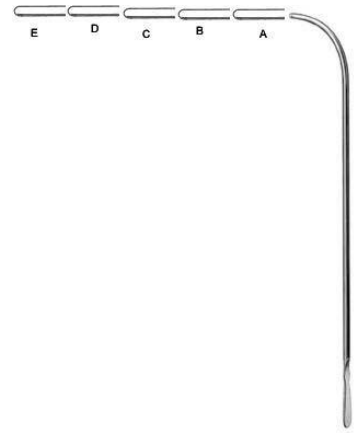

Van Buren
RI-19-127-00 A
Urethral Sound
27.5 cm,

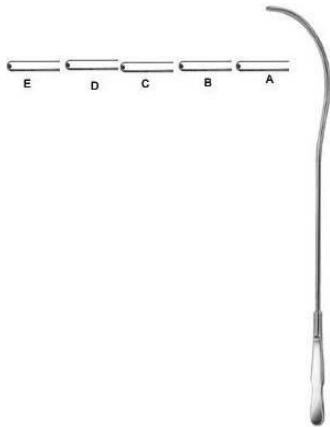

Guyon
RI-19-128-10 A
Urethral Sound
26 cm,

Gynecology



Cusco
RI-20-101
Vaginal Speculum
75 x 32 mm, 85 x 35 mm,



Cusco
RI-20-102-01
Vaginal Speculum
75 x 18 mm,



Cusco
RI-20-103-01
Vaginal Speculum
80 x 22 mm, 100 x 25 mm, 105 x 27 mm,



Cusco
RI-20-104-01
Vaginal Speculum
75 x 34 mm, 85 x 37 mm,



Collin
RI-20-105-01
Vaginal Speculum
85 x 30 mm, 100 x 35 mm,



Pederson
RI-20-106-01
Vaginal Speculum
75 x 13 mm, 100 x 22 mm,

Gynecology



Grave
RI-20-107-01
Vaginal Speculum
75 x 20 mm, 95 x 35 mm,



Semm
RI-20-108-01
Vaginal Speculum
100 x 20 mm, 105 x 27 mm,



Sims
RI-20-109-01
Vaginal Speculum
65 x 25 mm, 70 x 30 mm,



Kristeller
RI-20-110-01
Vaginal Speculum
70 x 27 mm,



Kristeller
RI-20-111-01
Vaginal Retractor
75 x 23 mm,



Kristeller
RI-20-112-01
Vaginal Speculum
Size 1,

Gynecology



Kristeller
RI-20-113-01
Vaginal Speculum
105 x 18 mm,



Kristeller
RI-20-114-01
Vaginal Retractor
110 x 14 mm,



Kristeller
RI-20-115-01
Vaginal Speculum
Size 1,

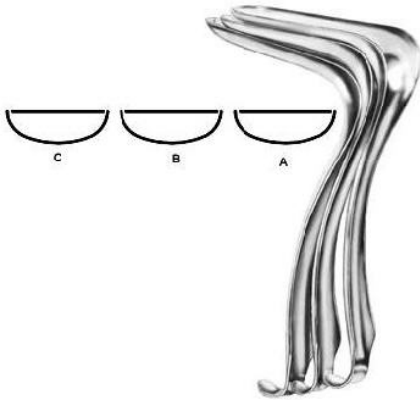

Kristeller
RI-20-116-01
Vaginal Speculum
105 x 26 mm,

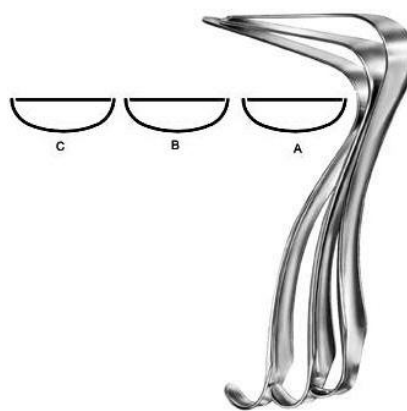

Kristeller
RI-20-117-01
Vaginal Retractor
115 x 22 mm, 115 x 24 mm,

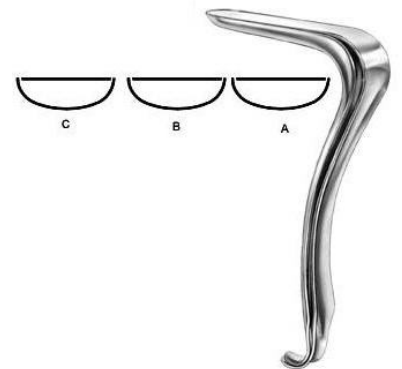

Kristeller
RI-20-118-01
Vaginal Speculum
Size 1,

Gynecology

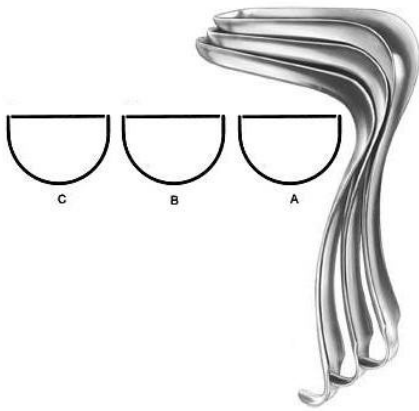

Kristeller
RI-20-119-01
 Vaginal Speculum
 110 x 27 mm,

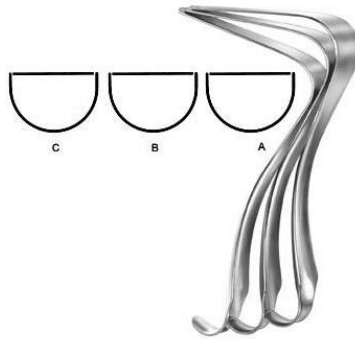

Kristeller
RI-20-120-01
 Vaginal Retractor
 115 x 23 mm,

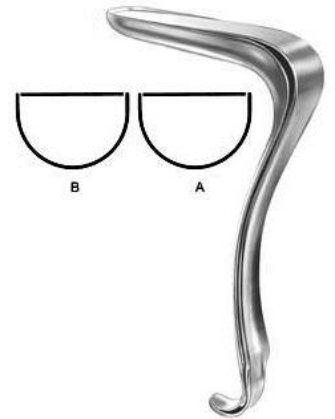

Kallmorgen
RI-20-121-01
 Vaginal Speculum



Kallmorgen
RI-20-122-01
 Vaginal Retractor
 70 x 40 mm Fig. 1, 90 x 40 mm Fig. 2,



Kallmorgen
RI-20-123-01
 Vaginal Speculum
 70 x 33 mm, 90 x 33 mm,

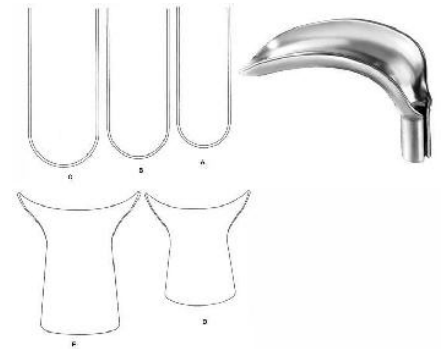

Scherbak
RI-20-125-00
 Vaginal Speculum
 Size 1,

Gynecology



Auvard
RI-20-126-22
Vaginal Speculum
80 x 43 mm,



Weissbarth
RI-20-127-24
Vaginal Speculum
21 cm 80 x 42 mm,



Breisky
RI-20-128-20
Vaginal Speculum
29 cm 100 x 20 mm, 29 cm 100 x 25 mm,



Kogan
RI-20-129-24
Endocervical Speculum
25 cm 70 x 30 mm,



Kogan
RI-20-130-24
Endocervical Speculum
24.5 cm,



Hegar
RI-20-131-24
Uterine Dilator
18.5 cm 1,0,

Gynecology



Hegar
RI-20-132-02
Uterine Dilator
20 cm 1,0,



Hank
RI-20-133-10
Uterine Dilator
26.5 cm Fig. 9/10,



Sims
RI-20-134-32
Uterine Sound
33 cm,



Valleix
RI-20-135-25
Uterine Sound
29.5 cm,



Braun
RI-20-136-26
Uterine Depressor
27.5 cm,



Schroder
RI-20-137-25
Uterine Tenaculum Forceps
25.5 cm,

Gynecology



Braun
RI-20-138-25
Uterine Tenaculum Forceps
26 cm,



Duplay
RI-20-139-28
Uterine Tenaculum Forceps
25.5 cm,



Beacham
RI-20-140-26
Amniotome
26 cm,



Skene
RI-20-141-24
Uterine Tenaculum Forceps
24 cm,

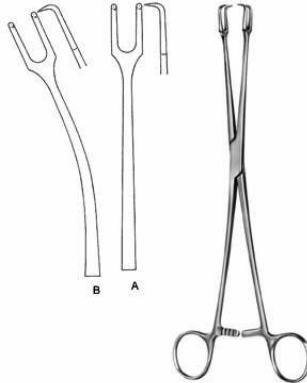

Schroder
IN-20-142-24
Uterine Tenaculum Forceps
25 cm,



Teale
RI-20-143-23
Uterine Tenaculum Forceps
23.5 cm,

Gynecology

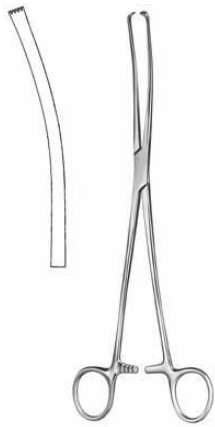

Iowa
RI-20-144-26
 Uterine Tenaculum Forceps
 26 cm,



Museux
RI-20-145-24
 Uterine Tenaculum Forceps
 24 cm,



Jacobs
RI-20-146-21
 Uterine Tenaculum Forceps
 21 cm,

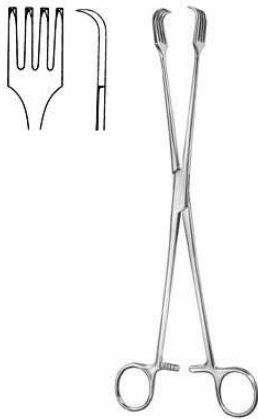

RI-20-147-26
 Uterine Tenaculum Forceps
 26.5 cm,



Braun
RI-20-148-16
 Uterine Tenaculum Forceps
 16 cm,

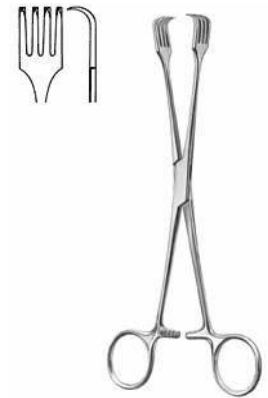

Czerny
RI-20-149-21
 Uterine Tenaculum Forceps
 21 cm,

Gynecology



Kelly
RI-20-150-32
Uterine Polypus Forceps
32 cm,



Noto
RI-20-151-27
Uterine Polypus Forceps
27 cm,

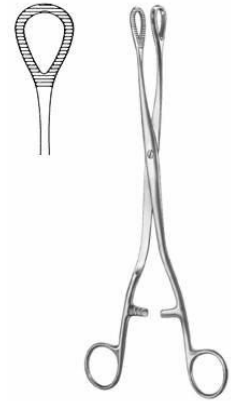

Heywood-Smith
RI-20-152-25
Uterine Polypus Forceps
25 cm,

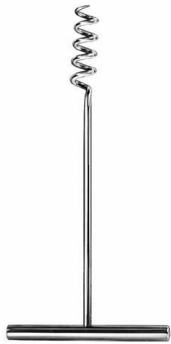

Doyen
RI-20-153-17
Myoma Screw
17 cm,



Doyen
RI-20-154-17
Myoma Screw
14.5 cm,



Segond
RI-20-155-27
Myoma Knife
28 cm,

Gynecology

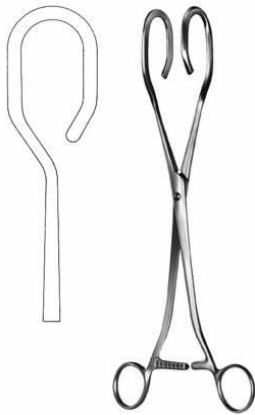

Dartigues
RI-20-156-27
Uterine Seizing Forceps
28 cm,



Somer
RI-20-157-27
Uterine Seizing Forceps
22.5 cm,



Collin
RI-20-158-25
Uterine Seizing Forceps jaw 40 mm wide
26 cm,



Ayre
RI-20-159-23
Conization Knife cutting edge 3,6 mm wide
23.5 cm,



Emmett
RI-20-160-03
Fistula Hook
22 cm Fig.3,



Simon
RI-20-161-22
Fistula Hook
21.5 cm,

Gynecology



Simon
RI-20-162-22
Fistula Hook
21.5 cm,



Novak
RI-20-163-23
Suction Curette 4 mm ?
24.5 cm,



Kevorkian
RI-20-164-23
Uterine Biopsy Curette 6,0 mm ?
30 cm,



Munchen
RI-20-165-27
Uterine Biopsy Curette 4,8 mm ?
27 cm,



Gellhorn
RI-20-166-23
Uterine Biopsy Forceps jaw 8,6 mm wide
24 cm,



Faure
RI-20-167-21
Faure Uterine Biopsy Forceps
21 cm,

Gynecology

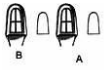

Schubert
RI-20-168-21

Uterine Biopsy Forceps jaw 4,8 mm wide
21.5 cm, 28 cm,

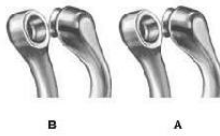

Thoms-Gaylor
RI-20-169-22

Uterine Biopsy Forceps jaw 5,6 mm ?
21 cm, 23.5 cm,

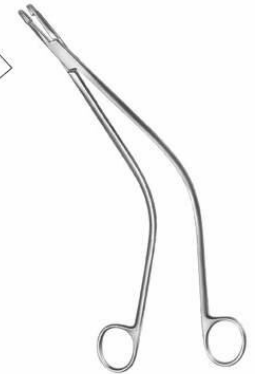

Schubert
RI-20-170-26

Schubert Uterine Biopsy Forceps
25.5 cm,

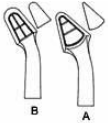

Van Doren
RI-20-171-24

Uterine Biopsy Forceps jaw 4,9 mm wide
27 cm, 25.5 cm,



Alexander
RI-20-172-28

Uterine Biopsy Forceps jaw 5,1 mm wide
28 cm,



Kevorkian
RI-20-173-32

Uterine Biopsy Forceps
25 cm,

Gynecology

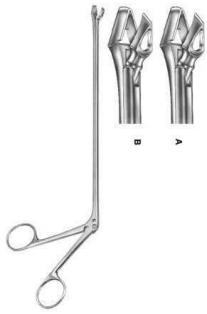

Schumacher
RI-20-174-01

Uterine Biopsy Forceps jaw 4,6 / 5,4 mm wide
24 cm,



Schumacher
RI-20-175-00

Uterine Biopsy Forceps
25 cm,



RI-20-176-22

IUP Grasping Forceps 3 mm ?
22 cm,

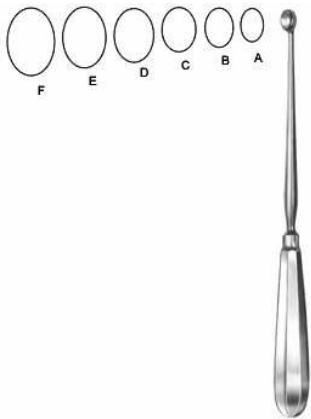

Simon

RI-20-177-01

Uterine Scoop
24.5 cm 9,8 x 8,6 mm, 24.5 cm 11,6 x 8,3 mm,



Simon

RI-20-178-01

Uterine Scoop
30 cm 9,8 x 8,6 mm, 30 cm 11,6 x 8,3 mm,



Recamier

RI-20-179-05

Uterine Curette
31 cm Fig. 00 5 mm, 31 cm Fig. 0 6 mm,

Gynecology



Recamier
RI-20-180-05

Uterine Curette
31 cm Fig. 00 5 mm, 31 cm Fig. 0 6 mm,



Sims
RI-20-181-05

Uterine Curette
31 cm Fig. 00 5 mm, 31 cm Fig. 0 6 mm,

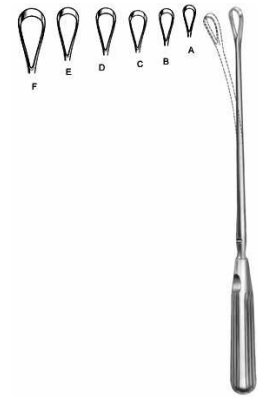

Sims
RI-20-182-05

Uterine Curette
31 cm Fig. 00 5 mm, 31 cm Fig. 0 6 mm,

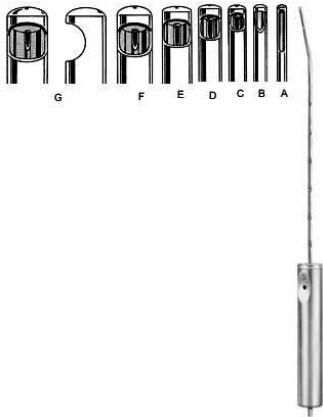

RI-20-183-03

Suction Curette
29 cm 3,0 mm ?, 29 cm 4,5 mm ?, 29 cm 6,0 mm ?,



Douay
RI-20-184-01

Douay
20 cm, 25 cm, 30 cm, 35 cm, 40 cm,



Thomas-Gaylor
RI-20-184-02

Thomas-Gaylor
22 cm, 24 cm,

Gynecology



Van Doren
RI-20-184-03
Van Doren
24 cm,



Schumacher-Van Doren
RI-20-184-04
Schumacher-Van Doren
24 cm,



Gellhorn
RI-20-184-05
Gellhorn
23 cm,



Schubert
RI-20-184-06
Schubert
21 cm, 28 cm,



Schubert
RI-20-184-07
Schubert
26 cm,



Faure
RI-20-184-08
Faure
21 cm,

Gynecology



ALEXANDER
RI-20-184-09
ALEXANDER
20 cm,



TISCHLER
RI-20-184-10
TISCHLER
23 cm,



TISCHLER-MINI
RI-20-184-11
TISCHLER-MINI
23 cm,



KEVORKIAN-PACIFIC
RI-20-184-12
KEVORKIAN-PACIFIC
23 cm,

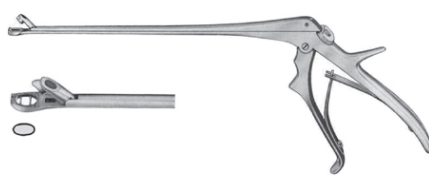

TISCHLER (Baggish)
RI-20-184-13
TISCHLER (Baggish)
23 cm,



TISCHLER-BURKE
RI-20-184-14
TISCHLER-BURKE
23 cm,

Gynecology

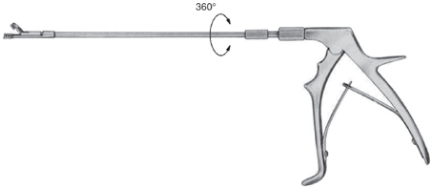

TOWNSEND
RI-20-184-15
Handle only
straight
curved up
curved down

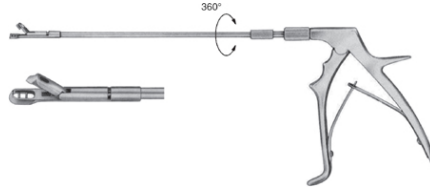

TOWNSEND-TISCHLER
RI-20-184-16
complete
tip only
360°,

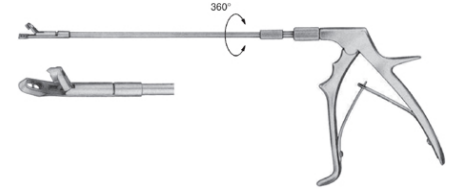

TOWNSEND-TISCHLER
RI-20-184-17
complete
tip only
360°,

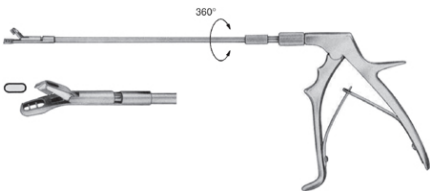

TOWNSEND-TISCHLER
RI-20-184-18
complete
tip only
360°,

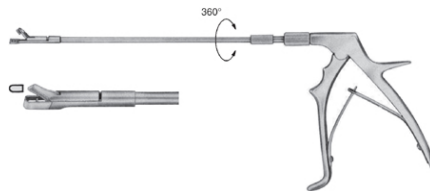

TOWNSEND-MINI
RI-20-184-19
complete
tip only
360°,

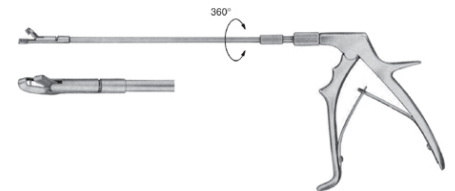

TOWNSEND-MINI
RI-20-184-20
complete
tip only
360°,

Gynecology

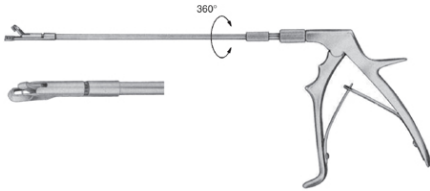

TOWNSEND-MINI
RI-20-184-21
 complete
 tip only
 360°,

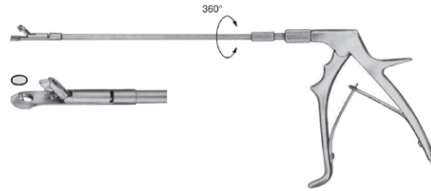

TOWNSEND-BURKE
RI-20-184-22
 complete
 tip only
 360°,

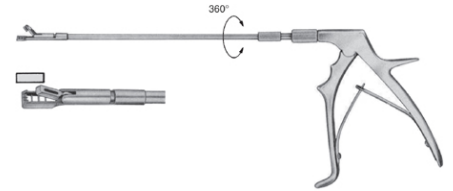

TOWNSEND-KEVORKIAN
RI-20-184-23
 complete
 tip only
 360°,

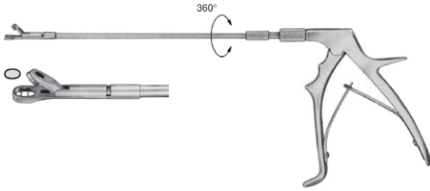

TOWNSEND-KRAUSE
RI-20-184-24
 complete
 tip only
 360°,



EPPENDORF
RI-20-184-25
 EPPENDORF
 20 cm,



WITTNER
RI-20-184-26
 straight
 curved
 23 cm,

Gynecology



SCHUMACHER
RI-20-184-27
SCHUMACHER
24 cm,



SCHUMACHER
RI-20-184-28
SCHUMACHER
24 cm,

Obstetrics



Martin
RI-21-101-34
Pelvimeter cm, inch scale
34 cm,



Nagele
RI-5-102-36
Obstetrical Forceps
35 cm, 40.5 cm,



Simpson
RI-5-103-30
Obstetrical Forceps
31 cm,



Wrigley
RI-5-104-28
Obstetrical Forceps
28 cm,



Simpson
RI-21-105-36
Obstetrical Forceps
36.5 cm,



Kielland
RI-21-106-41
Obstetrical Forceps
42 cm,

Obstetrics

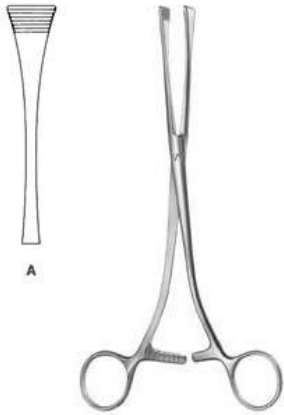

Green-Armytage
RI-21-107-21
 Uterine Clamp
 21 cm,



Sellheim
RI-21-108-28
 Obstetrical Lever
 32 cm,

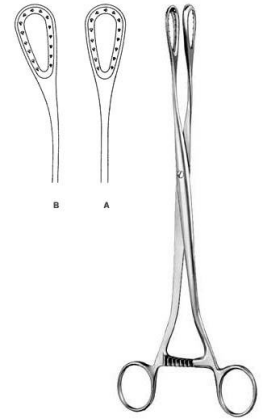

Sanger
RI-21-109-27
 Placenta and Ovum Forceps
 27.5 cm, 27 cm,

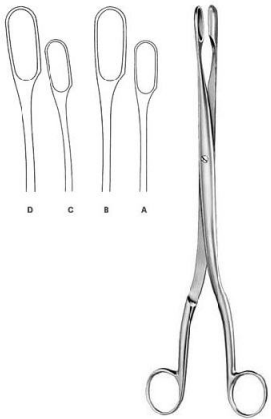

Winter
RI-21-110-01
 Placenta and Ovum Forceps
 28 cm Fig. 1, 28 cm Fig. 2,

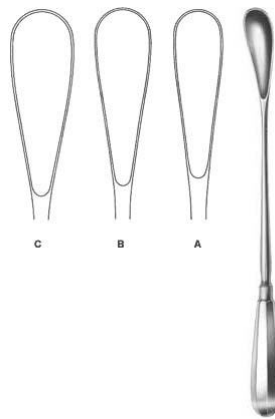

Cuzzi
RI-21-111-01
 Placenta Scoop
 30 cm 14,5 mm, 30 cm 18 mm,



Pestalozza
RI-21-112-30
 Placenta Scoop
 30 cm,

Obstetrics

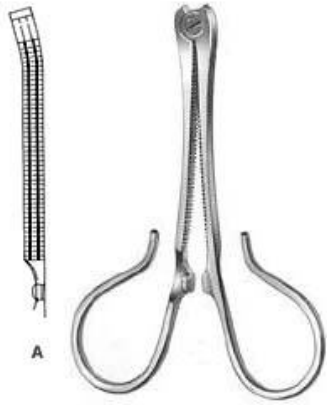

Kane
RI-21-113-08
Umbilical Cord Clamp
8.5 cm,



Collin
RI-21-114-09
Umbilical Cord Clamp
8.5 cm,

Sterilization



Irrigator
RI-23-101-10
Size 1,



Round Bowl
RI-23-102-16
220 mm x 70 mm, 400 mm x 150 mm,



RI-23-103-33
Round Bowl
? x h 6,00 l,



Flat Dish
RI-23-104-11
? x h 0,20 l,



Lid only
RI-23-105-11
Size 1,



Stainless Steel
RI-23-106-04
? x h 0,30 l,

Sterilization



Round Dish
RI-23-107-11

? x h 0,30 l, ? 128 x 38 mm 0,40 l,



Flat Dish
RI-23-108-11

? x h 0,15 l,



Measurer

RI-23-109-01

graduated inside
100cc = 0,1 l,



Measurer

RI-23-110-02

Graduated Inside
0,25 l, 0,50 l,



Petri Dish

RI-23-111-10

with Lid ? x h



Petri Dish

RI-23-112-09

without lid ? x h
Size 1,

Sterilization



Lid for Petri Dishes
RI-23-113-10
Size 1,



Universal Tray
RI-23-114-23
l x b x h,



Instrument Tray
RI-23-115-21
l x b x h,



Universal Tray
RI-23-116-23
l x b x h,



Round Bowl
RI-23-117-22
? x h,



Metal Jar
RI-23-118-30
? 30mm x 90 mm, ? 50mm x 100 mm,

Sterilization



Instrument Box
RI-23-119-16
lid with knob
l x b x h,



Instrument Box
RI-23-120-16
lid with knob
l x b x h,



Instrument Box
RI-23-121-20
l x b x h,



Round Metal Box
RI-23-122-06
? 75 mm x 75 mm, ? 100 mm x 60 mm,



Medicine Cup Graduated Inside
RI-23-123-25
25 ccm,



Medicine Cup Graduated Inside
RI-23-124-50
50 ccm,

Sterilization



Instrument Box
RI-23-119-16
lid with knob
l x b x h,



Instrument Box
RI-23-120-16
lid with knob
l x b x h,



Instrument Box
RI-23-121-20
l x b x h,



Round Metal Box
RI-23-122-06
? 75 mm x 75 mm, ? 100 mm x 60 mm,



Medicine Cup Graduated Inside
RI-23-123-25
25 ccm,



Medicine Cup Graduated Inside
RI-23-124-50
50 ccm,

Sterilization



Tablet Tray
RI-23-125-75
? 75 mm x 12 mm,



Metal Cup
RI-23-126-90
? 90 mm x 90 mm,



Denture Cup
RI-23-127-75
? 75 mm x 50 mm,



Insert for Cup
RI-23-128-75
? 73 mm x 75 mm,



Kidney Dish
RI-23-129-17
l x b x h,



Placenta Pan
RI-23-130-36
Size 1,

Sterilization



Waste Cotton Collector
RI-23-131-01
? 50 mm x 75 mm,



Spirit Lamp
RI-23-132-07
120 ccm,

Bone Surgery



Charrière
RI-7-102-35
Amputation Saw
35 cm,



Langenbeck
RI-7-103-23
Amputation Saw
24.5 cm,



Charrière
RI-7-104-27
Amputation Saw
26.5 cm,



RI-7-105-14
Reamer
13.5 cm,



Perthes
RI-7-106-18
Reamer
18 cm,

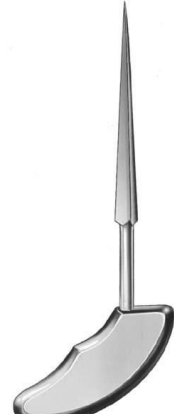

Perthes
RI-7-107-21
Reamer
21.5 cm,

Bone Surgery



RI-7-108-14
Reamer
14 cm,



RI-7-111-18
Flat Trepine

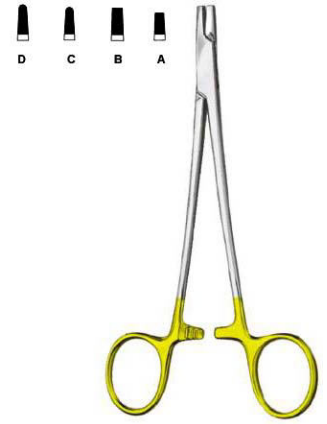

RI-7-112-01
Wire Twisting Forceps
15.5 cm, 18 cm, 20 cm,

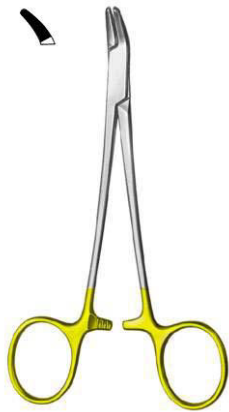

RI-7-113-15
Wire Twisting Forceps
15.5 cm,



RI-7-114-17
Flat Nose Plier
18.5 cm,



RI-7-115-18
Wire Twisting Forceps
19 cm,

Bone Surgery



RI-7-116-15
Combi-Flat Nose Plier
15 cm,

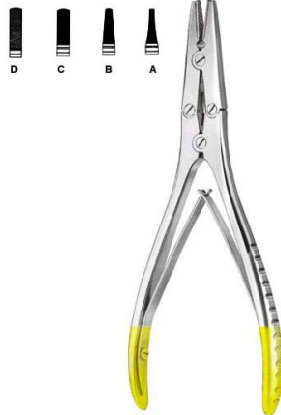

RI-7-117-01
Flat Nose Plier
18 cm,

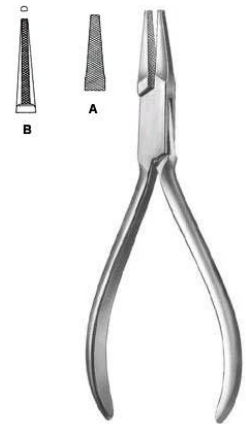

RI-7-118-14
Flat Nose Plier
13.5 cm,



Hackstock
RI-7-119-16
Flat Nose Plier
16 cm,



RI-7-120-01
Flat Nose Plier
17.5 cm,



RI-7-121-18
Wire Cutting Pliers
18.5 cm,

Bone Surgery



RI-7-122-15
Wire Cutting Pliers
15 cm,



RI-7-123-18
Wire Cutting Pliers
17.5 cm,



Demel
RI-7-124-18
Wire Guide
31 cm Fig. 1, 29 cm Fig. 2, 28 cm Fig. 3,

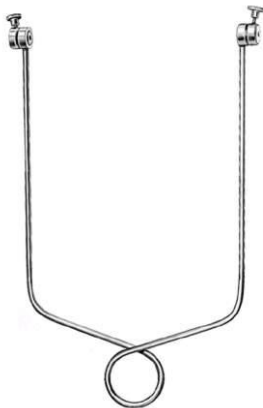

Bohler
RI-7-125-15
Extension Bow



Kirschner
RI-7-126-01
Extension Bow
18.5 cm, 26.5 cm,



RI-7-127-06
Traction Hook for Extension Bows

Bone Surgery



Kirschner
RI-7-128-06
Wire Drill
6 cm, 12 cm,



Kirschner
RI-7-129-06
Wire Drill
14 cm, 16 cm,



Kirschner
RI-7-130-10
Wire Drill
31 cm,



Kirschner
RI-7-131-10
Wire Drill
6 cm, 12 cm, 18 cm,



Kirschner
RI-7-132-10
Wire Drill
31 cm,



Buckley
RI-7-133-02
Chisel
16 cm,

Bone Surgery

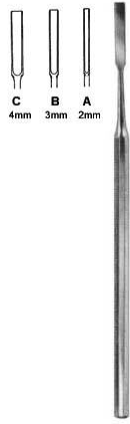

Buckley
RI-7-134-02
 Gouge
 16 cm,



Stout
RI-7-135-03
 Bone Chisel
 21 cm,



RI-7-136-04
 Bone Chisel
 18 cm,



RI-7-137-04
 Bone Chisel
 18 cm,



RI-7-138-04
 Bone Chisel
 17 cm,



RI-7-139-04
 Bone Chisel
 17 cm,

Bone Surgery

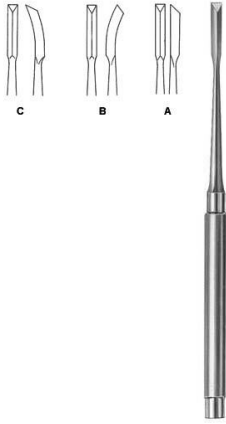

Gardner
RI-7-140-01
Bone Chisel
17 cm 4mm,



Snyder-O.S.U.
RI-7-141-03
Bone Chisel
16.5 cm 3mm, 16.5 cm 5.5mm,



O.S.U.
RI-7-142-01
one Chisel
17 cm 7mm,



O.S.U.
RI-7-143-01
one Chisel
17 cm 9mm,



RI-7-144-08
Osteotome
13.5 cm 8mm, 13.5 cm 10mm, 13.5 cm 12mm, 13.5 cm 14mm, 13.5 cm 16mm,

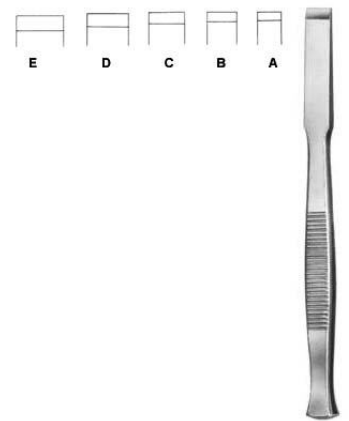

RI-7-145-08
Chisel
13.5 cm 8mm, 13.5 cm 10mm, 13.5 cm 12mm, 13.5 cm 14mm, 13.5 cm 16mm,

Bone Surgery



RI-7-146-08

Gouge

13.5 cm 8mm, 13.5 cm 10mm, 13.5 cm 12mm, 13.5 cm 14mm, 13.5 cm 16mm,



Partsch

RI-7-147-02

Chisel

13.5 cm 2mm, 13.5 cm 3mm, 13.5 cm 4mm, 13.5 cm 5mm, 13.5 cm 6mm, 17 cm 2mm, 17 cm 3mm, 17 cm 4mm, 17 cm 5mm, 17 cm 6mm,



Partsch

RI-7-148-02

Gouge

13.5 cm 2mm, 13.5 cm 3mm, 17 cm 2mm, 17 cm 3mm,

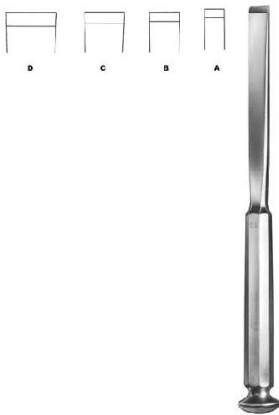

Stille

RI-7-149-10

Chisel

20 cm 10mm, 20 cm 15mm, 20 cm 20mm, 20 cm 25mm,



Stille

RI-7-150-10

Osteotome

20 cm 10mm, 20 cm 15mm, 20 cm 20mm, 20 cm 25mm,



Stille

RI-7-151-10

Gouges

20 cm 10mm, 20 cm 15mm, 20 cm 20mm, 20 cm 25mm,

Bone Surgery



Lambotte, Mini
RI-7-152-02

Osteotome
12.5 cm 2mm, 12.5 cm 3mm, 12.5 cm
4mm, 12.5 cm 6mm, 12.5 cm 8mm,



Lambotte
RI-7-153-15

Osteotome
24 cm 15mm, 24 cm 20mm, 24 cm 25mm, 24
cm 30mm,



Lambotte
RI-7-154-15

Osteotome
24 cm 15mm, 24 cm 20mm, 24 cm 25mm, 24
cm 30mm,



Smith-Petersen
RI-7-155-06

Osteotome
20.5 cm 6mm, 20.5 cm 9mm, 20.5 cm 13mm,



Smith-Petersen
RI-7-156-06

Osteotome
20.5 cm 6mm, 20.5 cm 9mm, 20.5 cm
13mm, 20.5 cm 16mm, 20.5 cm 19mm,



Smith-Petersen
RI-7-157-09

Gouge
20.5 cm 9mm, 20.5 cm 14mm, 20.5 cm
19mm, 20.5 cm 25mm,

Bone Surgery



Smith-Petersen
RI-7-158-09

Gouge
20.5 cm 9mm, 20.5 cm 14mm, 20.5 cm 19mm,



Hoke
RI-7-159-03

Osteotome
17 cm 3mm, 17 cm 5mm, 17 cm 6mm, 17 cm 8mm,

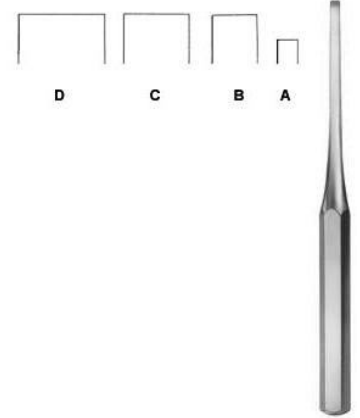

Hibbs
RI-7-160-06

Osteotome
24.5 cm 6mm, 24.5 cm 13mm, 24.5 cm 19mm,

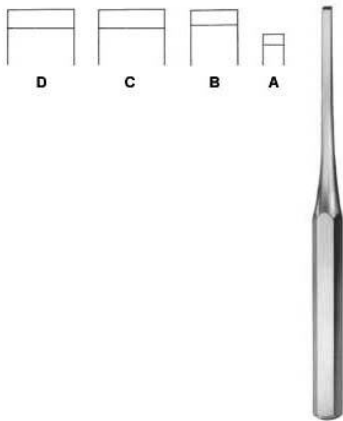

Hibbs
RI-7-161-06

Chisel
24.5 cm 6mm, 24.5 cm 19mm, 24.5 cm 13mm,

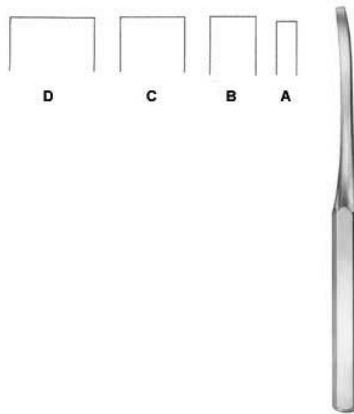

Hibbs
RI-7-162-06

Osteotome
24.5 cm 6mm, 24.5 cm 13mm, 24.5 cm 19mm,

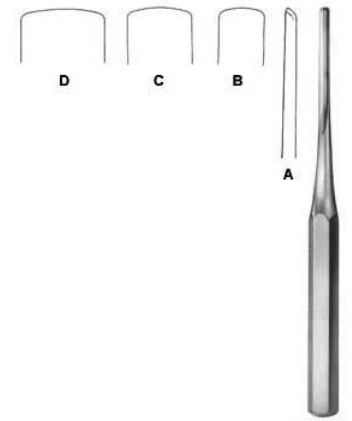

Hibbs
RI-7-163-06

Hibbs
24.5 cm 6mm, 24.5 cm 13mm, 24.5 cm 19mm,

Bone Surgery



Hibbs
RI-7-164-06
 Gouge
 24.5 cm 6mm, 24.5 cm 13mm, 24.5 cm 19mm,

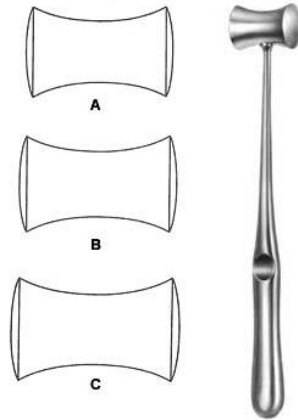

Williger
RI-7-165-01
 Mallet
 24 cm,

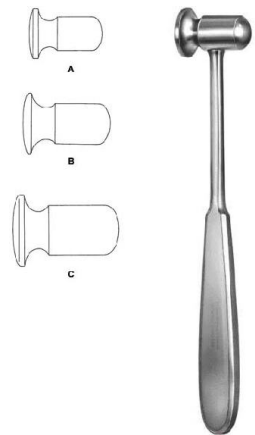

Doyen
RI-7-166-01
 Mallet
 20.5 cm, 21 cm, 21.5 cm,



Collin
RI-7-167-20
 Mallet
 20 cm,

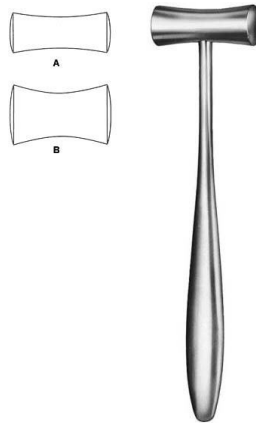

Lucae
RI-7-168-01
 Mallet
 19.5 cm,



Cottle
RI-7-169-19
 Mallet
 19 cm,

Bone Surgery



Williger
RI-7-170-01
 Mallet
 16.5 cm,



Mead
RI-7-171-17
 Mallet
 19 cm,



Partsch
RI-7-172-18
 Mallet
 19 cm,

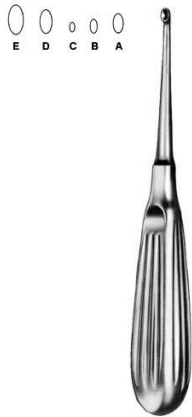

Schede
RI-7-173-01
 Bone Curette Fig. 0 to 4
 17 cm,



Volkman
RI-7-174-01
 Bone Curette
 17 cm Fig. 0, 17 cm Fig. 00, 17 cm Fig.
 000, 17 cm Fig. 1, 17 cm Fig. 2, 17 cm Fig.
 3, 17 cm Fig. 4,

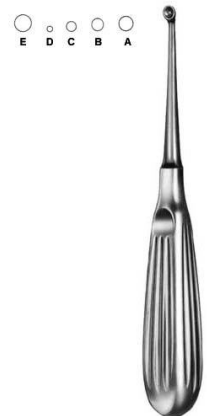

Bruns
RI-7-175-01
 Bone Curette
 17 cm Fig. 0, 17 cm Fig. 00, 17 cm Fig.
 000, 17 cm Fig. 1, 17 cm Fig. 2, 17 cm Fig.
 3, 17 cm Fig. 4,

Bone Surgery



Spratt

RI-7-176-01

Bone Curette

17 cm Fig. 0, 17 cm Fig. 00, 17 cm Fig. 000, 17 cm Fig. 0000, 17 cm Fig. 1, 17 cm Fig. 2, 17 cm Fig. 3, 17 cm Fig. 4, 17 cm Fig. 5,



Bruns

RI-7-177-01

Bone Curette

23 cm Fig. 0, 23 cm Fig. 00, 23 cm Fig. 000, 23 cm Fig. 1, 23 cm Fig. 2, 23 cm Fig. 3,



Scoville

RI-7-178-25

Bone Curette

25 cm,



Simon

RI-7-179-01

Bone Curette

25 cm Fig. 1, 25 cm Fig. 2, 25 cm Fig. 3, 25 cm Fig. 4, 25 cm Fig. 5,



Modell USA

RI-7-180-01

Bone Curette

16 cm Fig. 1, 16 cm Fig. 2, 16 cm Fig. 3, 16 cm Fig. 4,



Modell USA

RI-7-181-01

Bone Curette

15.5 cm Fig. 1, 15.5 cm Fig. 2, 15.5 cm Fig. 3, 15.5 cm Fig. 4,

Bone Surgery



Modell USA
RI-7-182-01

Bone Curette

15.5 cm Fig. 1, 15.5 cm Fig. 2, 15.5 cm Fig. 3, 15.5 cm Fig. 4,



Halle

RI-7-183-01

Bone Curette

21 cm Fig. 1, 21 cm Fig. 2, 21 cm Fig. 3,



Volkman

RI-7-184-01

Bone Curette, double-ended
12.5 cm, 14.5 cm, 17 cm,



Volkman

RI-7-185-13

Bone Curette, double-ended
13 cm, 16 cm,



RI-7-186-21

Bone Curette, double-ended
21 cm,



Williger

RI-7-187-00

Bone Curette, double-ended
13.5 cm Fig. 00/0, 13.5 cm Fig. 0/1, 13.5 cm
Fig. 1/2,

Bone Surgery



Hemingway
RI-7-189-11

Bone Curette, double-ended
18 cm,



Hemingway
RI-7-190-00

Bone Curette, double-ended
18.5 cm,



RI-7-191-01

Bone Curette, double-ended
17.5 cm,

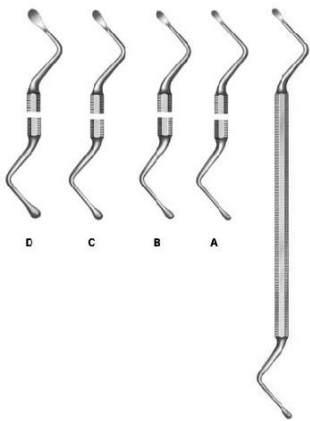

Lucas

RI-7-192-11

Bone Curette, double-ended
18 cm,

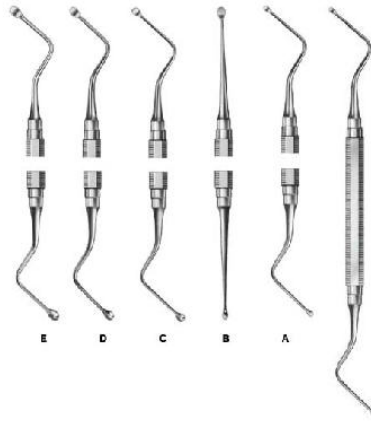

Miller-Colburn

RI-7-193-00

Bone Curette, double-ended
17 cm Fig. 0, 17 cm Fig. 1, 17 cm Fig. 2, 17 cm Fig. 3,

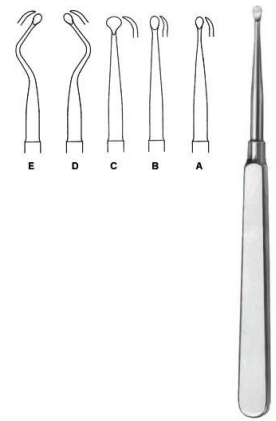

Molt

RI-7-194-01

Bone Curette
17 cm Fig. 1, 17 cm Fig. 2, 17 cm Fig. 3, 17 cm Fig. 4,

Bone Surgery

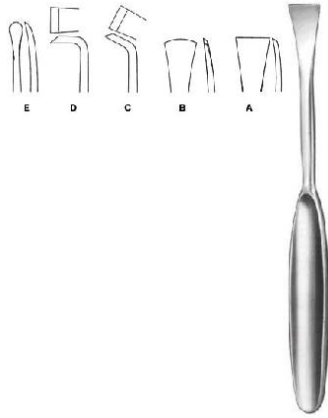

Martin-Langenbeck
RI-7-195-01
 Periosteal Elevator
 19 cm 16mm,



Langenbeck
RI-7-196-18
 Periosteal Elevator
 18.5 cm,



Langenbeck
RI-7-197-19
 Periosteal Elevator
 19.5 cm,



RI-7-198-05
 Periosteal Elevator
 16 cm 5mm, 16 cm 6mm, 16 cm 7mm,



Sedillot
RI-7-199-21
 Periosteal Elevator
 22 cm 15mm,



Williger
RI-7-200-13
 Periosteal Elevator
 12.5 cm 5mm,

Bone Surgery



Kahre-Williger
RI-7-201-04
 Periosteal Elevator
 4 mm, 5 mm, 7 mm,

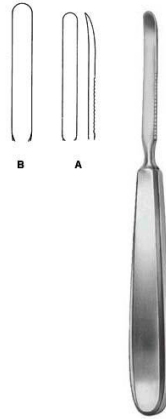

RI-7-202-06
 Periosteal Elevator
 17 cm 6 mm, 17 cm 8 mm,



Doyen
RI-7-203-17
 Rib Raspatory
 17.5 cm,

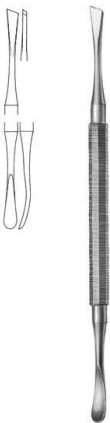

West
RI-7-204-19
 Periosteal Elevator, double-ended
 18.5 cm,



Ohl
RI-7-205-17
 Periosteal Elevator, double-ended
 17.5 cm,



Semb
RI-7-206-01
 Periosteal Elevator
 18.5 cm Fig. 1, 21.5 cm Fig. 2,

Bone Surgery



RI-7-207-22
Bone File
22 cm,

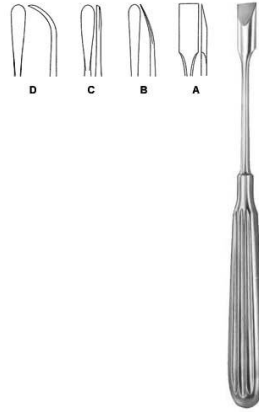

Adson
RI-7-208-17
Elevator
17 cm, 17.5 cm,

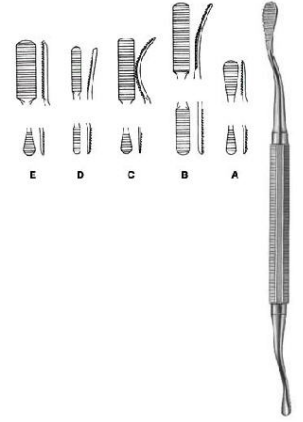

Miller-Colburn
RI-7-209-01
Bone File
18 cm Fig. 1, 18 cm Fig. 2, 18 cm Fig. 3, 18 cm Fig. 4, 18 cm Fig. 5,

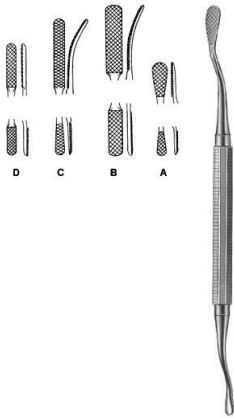

Miller-Colburn
RI-7-210-01
Bone File
18 cm Fig. 1, 18 cm Fig. 2, 18 cm Fig. 3, 18 cm Fig. 4,



Langenbeck
RI-7-211-20
Elevator
19.5 cm 8 mm, 19.5 cm 10 mm,

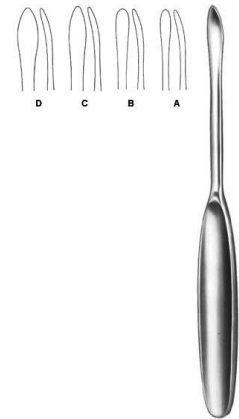

Martin-Langenbeck
RI-7-212-01
Elevator
17 cm 5 mm, 17 cm 7 mm, 17 cm 8 mm,

Bone Surgery

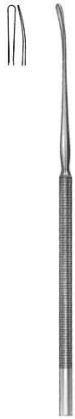

Vickers
RI-7-213-17
Elevator
17 cm,



Vickers
RI-7-214-17
Dissector
17 cm,



Williger
RI-7-215-17
Elevator
16 cm 5,5 mm,



Williger
RI-7-216-16
Elevator
16 cm 5,5 mm,



Mead
RI-7-217-17
Mallet
19 cm,



RI-7-218-18
Periosteal Elevator

Bone Surgery



Hohmann
RI-7-219-43
Bone Lever
23.5 cm,



Lempert
RI-7-220-19
Bone Rongeur
19 cm,



Luer
RI-7-221-17
Bone Rongeur
18.5 cm, 18 cm,



Zaufal-Jansen
RI-7-222-18
Bone Rongeur
18 cm,

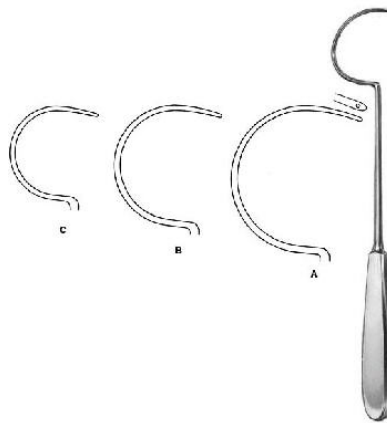

Demel
RI-7-124-01
Wire Guide
31 cm Fig. 1, 29 cm Fig. 2, 28 cm Fig. 3,

Micro Surgery



straight
RI-20-185-01
straight



straight
RI-20-185-02
straight



straight
RI-20-185-03
straight



curved up
RI-20-185-04
curved up



curved up
RI-20-185-05
curved up



curved up
RI-20-185-06
curved up

Micro Surgery



curved to right
RI-20-185-07
curved to right



curved to right
RI-20-185-08
curved to right



curved to left
RI-20-185-09
curved to left



curved to left
RI-20-185-10
curved to left



straight
RI-20-185-11
straight
1,0 mm Ø, 1,5 mm Ø, 2,0 mm Ø, 2,5 mm Ø,



ENTERPRISE

CONTACT US

Rohtas Enterprise

Address:

Nzam Abad Shafi Tha Patha Near Al noor Marriage,
Hall Bagowal Road, Sialkot-51310, Pakistan

Phone : +92-52-3543222, 3543223, 3543224

Phone : +92-3543227,3543228

Fax : +92-52-4568882

E-mail : info@rohtasentp.com

